

A Review of Environmental Assessments of Biodiesel Displacing Fossil Diesel

Prepared with support from:
The Canola Council of Canada
&
Auto21 Network of Centres of Excellence

July 8th 2006

Assessment Team:

Bruce Ainslie,
Post-Doctoral Research Fellow,
Earth and Ocean Sciences.
The University of British Columbia.

Hadi Dowlatabadi,
Canada Research Chair
Institute for Resources, Environment & Sustainability.
The University of British Columbia.

Naoko Ellis,
Assistant Professor,
Department of Chemical Engineering.
The University of British Columbia.

Francis Ries
Research Associate
Institute for Resources, Environment & Sustainability.
The University of British Columbia.

Mahbod Rouhany
Principal
Paya Solutions, Vancouver, BC

Hans Schreier
Professor
Agriculture and Food Sciences &
Institute for Resources, Environment & Sustainability.
The University of British Columbia.

Reviewed by:

Heather MacLean
Associate Professor
Department of Civil Engineering
University of Toronto

©2006 Paya Solutions Inc.

This report was sponsored by the Canola Council of Canada and the Auto21 Network of Centres of Excellence. It reflects the expert opinion of its authors and not the sponsoring bodies. Remaining errors in the report are the authors' responsibility. Paya

Solutions Inc. specifically disclaims any responsibility for losses or damages arising from the use of this report.

Executive Summary

In 2005, more than 17.5 billion litres of diesel was used in road, rail, sea and pipe transportation. This represents more than 28% of all transportation fuels sold in Canada. Diesel engines have a long history of being more durable and more efficient than spark ignition engines. This has made them the engine and fuel of choice in heavy duty applications such as trains, busses, and trucks. When compared to gasoline engines, the modern diesel engines offer fuel savings of about 25%. Such fuel savings already represents significantly lower emissions of greenhouse gases associated with transportation services.

Biodiesel is a renewable fuel produced from vegetable or animal oils. It can be used in diesel engines with little or no modification, and can be blended with fossil diesel for general use. Biodiesels offer a significant opportunity for further reductions in dependence on fossil fuels and emission of greenhouse gases.

This assessment reviews the environmental impacts of producing and using biodiesel in Canada. This is a full life-cycle study starting with inputs to agricultural production of feedstock to exhaust emissions of using biodiesel blends. We place special emphasis on using biodiesel produced from Canola as feedstock to replace fossil-diesel. This review explores and quantifies net gains in: energy, air quality and human health. It also documents net reductions in greenhouse gas emissions, use of agrichemicals, and water. The overall benefits of biodiesel compared to fossil diesel from an environmental perspective are overwhelming. Any significant blend of biodiesel will not only reduce greenhouse gases, but also improve air quality. We estimate the market share of a B5 blend (5% biodiesel and 95% fossil diesel) to be 1 billion litres of biodiesel by 2010. The market share of diesel powered light duty vehicles will remain limited until the Tier II emission standards are met by more manufacturers. The key challenge lies in reducing NO_x emissions. While no modern diesel engines have been optimized for operation using biodiesel blends, the laboratory tests show modern power plants to emit less NO_x when operated using biodiesel.

For biofuels to reduce dependence on fossil fuels, they need to deliver more energy than is used to produce them. Making biodiesel requires energy inputs to farming, harvesting, crushing, processing canola oil and delivery to consumers. In Canada, by consuming one unit of fossil energy, we can produce 2.5 units of biodiesel energy. The production, refining and delivery of fossil diesel also involve energy inputs. By using 1 unit of fossil energy, we currently produce 4 units of fossil diesel. As more of Canada's oil is produced from tar-sands, the energy input to produce fossil diesel will grow and the total inputs to producing fossil diesel and biodiesel will converge. However, biodiesel is a renewable fuel and it recycles carbon through plant growth. The use of biofuels is an important element of any strategy for reducing greenhouse gas emissions. In the case of ethanol each unit of energy input produces 1.5 units of delivered renewable energy.

While biofuels reduce fossil fuel use, agriculture has its own impacts on climate change, most notably, CO₂ from soils and nitrous oxide (N₂O) from fertilisers. However, zero-till cultivation has led to soil conservation as well as more carbon storage in soils. Furthermore, the dry cool conditions under which canola is grown in Canada leads to

N₂O emissions that are only 10% of estimates used in IPCC studies. In terms of GHG savings, this is equivalent to an additional 1kg of CO₂ saved per litre of biodiesel displacing fossil diesel.

New, conservation tillage, farming practices have been shown to increase organic carbon in the soil. At least for the first twenty years of canola production with new tillage practices, each unit of biodiesel consumed will not only avoid emissions of greenhouse gases associated with fossil fuel combustion, it will reduce CO₂ in the atmosphere by a further 1kg of CO₂ per litre for twenty years.

After taking into account the greenhouse gas emissions for biodiesel and fossil diesel from production to delivery to consumers we calculate that in 2005, biodiesel provides a 110% reduction in emissions when replacing fossil diesel. This advantage falls to 85% by 2020 as a consequence of two opposing trends. By 2020 there will be little or no further carbon sequestration in soils due to conservation tillage. Meanwhile, the emissions associated with producing fossil fuels will be rising due to increasing dependence on tar sands for liquid fuels.

Canola production in Canada is almost exclusively rain fed. Thus, the impact on water quantity is negligible. Producing canola requires agrochemicals to control pests and weeds. New production techniques and the introduction of herbicide resistant canola varieties have reduced the use of chemicals dramatically. The active ingredients of herbicides have declined by more than 40% since 1995 ¹, with significant improvements in water quality.

Once the biodiesel is in use the main question is what impact it will have on air quality. Historically, the use of fossil diesel and technology has raised concerns about particulate and NO_x emissions, as well as emission of toxics that are suspected carcinogens. However, biodiesel blends tested in a variety of engines have shown reductions in emissions of particulate matter (PM), carbon monoxide (CO), and hydrocarbons (HC). Emissions of NO_x have shown a range of outcomes depending on the engines, test cycles and feedstock for the biodiesel, with lower emissions where tallow is used and slightly higher emissions with vegetable based biodiesels. Limited modeling of the Los Angeles air shed, assuming all heavy-duty vehicles use B20 shows no impact of biodiesel use on ozone or PM formation. Biodiesel use in boilers and furnaces shows a decrease in NO_x and smoke emissions.

Despite the small increase in NO_x emissions observed in some tests, a more relevant observation is that biodiesels have low sulphur content and high lubricity. Thus, they are a perfect blend for low sulphur diesels which can harm engines without added lubricity. Thus, biodiesel blends facilitate the adoption of low sulphur fuels enabling the widespread use of sulphur-sensitive emission control devices. These pollution control measures promise NO_x emission reductions far exceeding current practice.

While the ozone precursor impacts have been the focus of many studies, the key benefit from bio-based diesel is reduction in toxic emissions. The critical question is whether the slight changes in NO_x, PM, and CO have a significant health impact. Changes associated with adoption of B20 for the HDV fleet in the Los Angeles air shed

are not expected to have a measurable impact. However, a 5% reduction in the risks associated with toxic emissions is estimated from modeling results for the Los Angeles air shed. The same modelling work shows no change in risk associated with NO_x, ozone and PM exposure.

Finally, in the event of accidental spills, biodiesel blends are far less harmful than fossil diesel. Regrettably, there are roughly 3000 spills in Canada each year (each averaging 9 tons/spill). Diesel spills impact aquatic, terrestrial and human health because of their volatile gasses and toxic emissions. Biodiesel does not emit toxics or carcinogenic compounds and is highly biodegradable. With a half-life of a few days, spills dissipate quickly as opposed to fossil diesel which has a half-life of one or more months. Spills of biodiesel blends are expected to be far less harmful in the environment.

In summary, this evaluation has looked into the impact of producing and using biodiesel from every stage of its production and use. We have found that the production of biodiesel using canola as a feedstock reduces dependence on fossil energy by 85% per unit of fossil diesel displaced. Biodiesel production and use also decreases greenhouse gas emissions by between 85 and 110% per unit of fossil diesel displaced. Its most remarkable impact on air quality is the elimination of toxic emissions. Its use has also been shown to reduce particulate emissions, carbon monoxide and hydrocarbons. NO_x emissions can be slightly higher in conventional engines. However, airshed models have shown this increase not to be significant in formation of secondary air pollutants and human health effects. With the advent of low sulphur fossil diesel, biodiesels can be used in a low-sulphur blend that increases lubricity and cetane number and is compatible with the adoption of much more effective NO_x reduction technologies. Finally, biodiesel is biodegradable and even in blends much less harmful to terrestrial and aquatic ecosystems when accidentally spilt.

Table of contents

1	INTRODUCTION	1
1.1	LIFE CYCLE ASSESSMENT	1
1.2	SCOPE AND OBJECTIVE	2
2	ON FARM OPERATIONS & ENVIRONMENTAL IMPACTS	5
2.1	INTRODUCTION.....	5
2.2	PRODUCTION & YIELD	5
2.3	MATERIALS CONSUMPTION.....	6
2.3.1	<i>Seed</i>	6
2.3.2	<i>Fertilizers</i>	7
2.3.3	<i>Agrochemicals</i>	8
2.4	ENERGY AND EQUIPMENT USE.....	9
2.5	EMISSIONS & ENVIRONMENTAL IMPACTS	10
2.5.1	<i>Energy Emissions</i>	10
2.5.2	<i>Soil Carbon Sequestration</i>	13
2.5.3	<i>Agrochemicals</i>	14
2.5.4	<i>N₂O Emissions from Soil</i>	14
2.5.5	<i>Soil Erosion</i>	18
2.5.6	<i>Water Use</i>	18
2.6	SUMMARY AND CONCLUSIONS	19
3	FROM GRAIN TO OIL.....	21
3.1	INTRODUCTION.....	21
3.2	FEEDSTOCK TRANSPORT	21
3.3	CRUSHING / OIL PRODUCTION.....	22
3.3.1	<i>Canola Seed Grading and Cleaning</i>	23
3.3.2	<i>Canola Seed Preconditioning</i>	23
3.3.3	<i>Canola Seed Processing</i>	24
3.3.4	<i>Solvent Extraction of Canola</i>	24
3.3.5	<i>Stripping and desolventizing</i>	24
3.3.6	<i>Degumming of Oil</i>	25
3.4	CANOLA AND SOY	25
3.4.1	<i>Canola Crushing Operations</i>	25
3.4.2	<i>Soybean Crushing Operations</i>	26
3.4.3	<i>Life Cycle Inventory of Canola and Soybean Crushing Operations</i>	27
3.5	ANIMAL AND WASTE FATS.....	28
4	FROM VEGETABLE OIL TO DIESEL.....	33
4.1	INPUTS AND OUTPUTS	33
4.2	TRANSESTERIFICATION REACTION	35
4.3	FEEDSTOCK	36
4.4	CATALYST.....	36
4.5	ETHANOL FOR TRANSESTERIFICATION.....	37
4.6	PROCESS.....	37
5	SPILLS.....	38
6	FROM COMBUSTION TO ENVIRONMENTAL IMPACTS	40
6.1	INTRODUCTION.....	40
6.2	EMISSIONS.....	40
6.2.1	<i>Mobile Sources</i>	40
6.2.2	<i>Stationary Sources</i>	44
6.3	IMPACTS	45

6.3.1	<i>Ambient Concentrations</i>	45
6.3.2	<i>Health Impacts</i>	46
6.3.3	<i>Acid Rain</i>	46
6.4	CONCLUSION.....	46
7	FOSSIL-DIESEL LIFE CYCLE	48
7.1	INTRODUCTION.....	48
7.2	FOSSIL-DIESEL LIFE CYCLE ANALYSIS FOR CANADA	48
7.3	FOSSIL-DIESEL EMISSION DISCUSSION	49
7.4	SUMMARY AND CONCLUSIONS.....	51
8	THE STATE OF LIFE CYCLE ANALYSIS	52
9	REFERENCES	55
10	APPENDICES	62

List of Tables

Table 1-1 LCA methods and boundary comparisons	3
Table 2-1 Canadian Canola and Soybean Yield Data 1995 - 2005 ^{2,3}	5
Table 2-2 Canadian Canola and Soybean Oil Content and Seed Requirements ^{4,5}	6
Table 2-3 Canadian Canola & Soybean Fertilizer Requirements ^{4,6}	7
Table 2-4 Canadian Canola and Soybean Soil Nutrient Removal Rates ⁴	8
Table 2-5 Total Energy Inputs & Outputs for Conventional and Conservation Tillage Canola and Field Pea Production (MJ/ha)	10
Table 2-6 GHG Emissions from N-fertilizer usage in Canola Agriculture ²	11
Table 2-7 GHG Emissions Comparison for Conservation and Conventional Till for 1 tonne canola produced ²	13
Table 2-8 GHG Emissions Comparison for Conservation and Conventional Till for 1 tonne canola produced.....	13
Table 2-9 Canola and Soybean N ₂ O Contribution to GHG Emissions ²	16
Table 2-10 Agricultural Water Efficiency of biodiesel production by crop	18
Table 3-1 LCA of US Soybean Transport to Crusher ⁵	21
Table 3-2 LCI of canola crushing ²	25
Table 3-3 Overall inputs and outputs for soybean crushing ²	26
Table 3-4 LCI data for crushing of 1 tonne of canola and soybean with mass allocation ^a . ²	27
Table 3-5 Energy requirements for a tonne of bio-diesel from rendering tallow ⁷	31
Table 3-6 LCI inputs and outputs for production of 1 tonne of tallow - with mass allocation ²	31
Table 4-1 Environmental inputs and outputs for biodiesel conversion ⁵	33
Table 4-2 Mass and energy balance calculations for an average US refinery	34
Table 4-3 Energy Inputs for diesel production in an average US refinery ⁵	34
Table 4-4 Transesterification input requirements per tonne of biodiesel ⁴)	37
Table 7-1 Total upstream ^a emissions of 50ppm Sulphur diesel in Canada (GHGenius)	49
Table 7-2 Urban Autobus emissions not including upstream emissions (GHGenius).....	50
Table 8-1 Comparison between different impact assessment methods (adapted from Niederl and Narodoslowsky ⁸)	53
Table 10-1 Life Cycle Analysis Inputs for Canadian Canola and Soybean Production (kg inputs / tonne production) ²	62
Table 10-2 Life Cycle Inventory Outputs for Canadian Canola and Soybean Production (g outputs / tonne production) ²	62
Table 10-3 Leaks and flares.....	65
Table 10-4 LCA of fossil oil production	65
Table 10-5 LCA of oil transport to refinery	65
Table 10-6 LCA of oil refining	66
Table 10-7 LCA of fuel storage and distribution	66
Table 10-8 LCA of fuel dispensing.....	66

List of Figures

Figure 1-1 Comparison of fossil-diesel and biodiesel life cycles from "well to wheel."	2
Figure 2-1 Estimated acreage, production, and percentage of Herbicide Tolerant (HT) and Conventional Canola in Canada.....	9
Figure 2-2 Rising price of gas has pushed up the price of anhydrous ammonia ¹⁵	12
Figure 3-1 Canola crush processes ³	22
Figure 3-2 Canola crushing process adapted with modifications from ³	23
Figure 3-3 Rendering process ⁷	29
Figure 3-4 Mass and energy balance for rendering ²	30
Figure 4-1 Overview of the transesterification process for conversion of soybean oil to biodiesel (flows in kg/h) ⁵	36
Figure 6-1 Commercial vehicles, longhaul trucks and urban transit account for more than 12 million litres of sales while private automobiles consumer about 10% of that volume in diesel fuel per year.	41

Glossary

B5	A blend of 5% biodiesel and 95% fossil diesel. B10, B20 are simply blends of 10% and 20% biodiesel.
Cetane Number	A measure of fuel ignition characteristics. Like the octane number used for gasoline, the higher the value, the better the fuel performance. A higher cetane number correlates with improved combustion, improved cold starting, reduced noise, white smoke, HC, CO and particulate emissions particularly during the early warm-up phase. Typical cetane numbers vary by region due to characteristics of the crude oil supply: average in Europe: 50, U.S.: 43. Canola and soy Biodiesel have a cetane range of 45-65.
CO	Carbon monoxide, a criteria air pollutant.
CO ₂	Carbon dioxide, the most prevalent greenhouse gas.
CO ₂ equivalent	This is a system of units adopted to measure the impact of different greenhouse gases on the same footing. It is expressed in terms of kg of CO ₂ and reflects the amount of CO ₂ emissions that would equal in global warming potential (GWP) of one or more sources of CO ₂ or other greenhouse gases.
Downstream	Energy and emissions to produce and deliver the product from this point onwards.
Esters	Any of a large group of organic compounds formed when an acid and alcohol is mixed. CH ₃ COOCH ₃ (Methyl acetate) is the simplest ester. Biodiesel contains methyl stearate.
Ethanol	Ethyl alcohol - C ₂ H ₅ OH - CH ₃ -CH ₂ -OH. A biofuels. An additive for gasoline, and a less efficient chemical for transesterification of oils into biodiesel.
GHG	Greenhouse gases are chemicals in the atmosphere that have high infrared absorption capacity and through that impact the earth's radiative energy balance.
Glycerine	The major by-product of Biodiesel production. CH ₂ -OH--CH-OH--CH ₂ -OH - Each of the "OH" sites is one of the three places where an ester is broken off from the triglyceride molecule (veg. oil).
GWP	Global warming potential, a measure of the impact of different gases on the climate system using carbon dioxide as a benchmark.
HDV	Heavy duty vehicles –weigh more than 8500 pounds and are typically diesel powered. They are used as busses, trucks and other service vehicles.
HR	Herbicide resistant crops allow effective management of weeds using less agrochemicals.

IPCC	Intergovernmental Panel on Climate Change is the scientific body coordinated by the World Meteorological Office and the United Nations Environment Program to assess the state of science.
LCA	Life Cycle Assessment involves tracing the inventory, emissions and impacts associated with a production process (or service) and judgement about its advisability.
LCE	Life Cycle Emissions, involves characterisation of all emissions associated with the manufacture and use of a product.
LCI	Life Cycle Impacts, an evaluation of how inputs and production processes impact environmental quality and human health.
LCI	Life Cycle Inventory, a list of all inputs and outputs needed in an LCA.
LDV	Light duty vehicles – weigh less than 8500 pounds and in N. America are commonly gasoline powered. They are used in light commercial and private service.
Methanol	Methyl Alcohol - CH ₃ OH - Good solvent and a component of gasohol. Burned in top fuel eliminator dragsters and toy airplane engines. Lethal if consumed. Used to make methoxide in Biodiesel production. Methanol absorbs water from the air and only methanol which is known to be dry (anhydrous) or is 99.9% pure should be used in Biodiesel production.
NMVOC/ROC	Non-methane volatile organic compounds / reactive organic compounds – these are a family of organic compounds that are volatile and reactive in normal atmospheric conditions. Together with NO _x they are precursors to formation of ground level ozone.
N ₂ O	Nitrous oxide – is a greenhouse gas with each molecule hundreds of times more potent than CO ₂ .
NO _x	Nitrogen oxides, a family of oxides of nitrogen formed in during high temperature fuel combustion. These compounds are important in ground level air quality.
O ₃	Ozone – is a highly reactive chemical made of three oxygen atoms. Ozone is produced by photoreaction and at ground level is a product of reactions between volatile organic compounds (VOC) and nitrogen oxides (NO _x)
PM	Particulate matter, respirable solid particles often referred to by size, e.g., PM _{2.5} , particles of less than 2.5 micron across.
SOC	Soil organic carbon – is a measure of the amount of carbon in the soil stored in the form of various organic compounds.
Transesterification	Process of creating esters from vegetable oil (a triglyceride), and sodium-methoxide. Products are glycerine, methyl-stearate, methyl-oleate, methyl-linoleate (assuming soy oil is used).

Upstream

Energy and emissions to produce and deliver the product to this point.

1 Introduction

Biodiesel is a renewable diesel fuel substitute that can be made by chemically combining any natural oil or fat with an alcohol such as methanol or ethanol. The term biodiesel usually refers to alkyl esters of fatty acids that meet transportation fuel standards. Today, biodiesel is made from a variety of natural renewable sources. Oilseed crops such as canola, soy and corn, recycled cooking oils, and animal fats are examples of such sources. Biodiesel derived from canola has the potential to be a renewable transportation fuel that can replace petroleum diesel. Canada produced 9.66 million tonnes of canola in 2005 and is predicted to have slightly in excess of a 2.0 million tonnes of inventory for the crop year 2005-06. Many environmental and social advantages have been attributed to the use of biodiesel as a substitute for fossil-diesel, but to properly compare the environmental impacts of these two fuels, the full life cycle of both products should be considered.

1.1 Life Cycle Assessment

Life Cycle Assessment (LCA) is a comprehensive quantification of all the energy and environmental flows associated with a product from "cradle to grave." An LCA provides information on:

- Raw materials extracted from the environment,
- Air, water, and solid waste emissions generated, and
- Energy resources consumed

LCA's are invaluable tools for assessing and comparing the overall environmental impacts of various products. The International Standards Organization (ISO) is promoting a standardised approach for LCA through ISO 14040. Many different criteria can be used to evaluate alternatives to fossil fuels. In the case of this study, we are interested in energy security, air quality, greenhouse gas emissions and ecosystem impacts of spills.

Figure 1-1 compares the Lifecycles of biodiesel and fossil-diesel fuels. The main operations included within the boundaries of a fossil-diesel system are:

- Extraction of crude oil
- Transport of crude oil to an oil refinery
- Refining of crude oil to diesel fuel
- Transport of diesel fuel to its point of use
- Use of the fuel in a diesel engine.

For a canola biodiesel system, the major operations include:

- Producing canola
- Transport of canola to a canola crushing facility
- Recovering canola oil at the crusher
- Transport of canola oil to a biodiesel manufacturing facility
- Conversion of canola oil to biodiesel
- Transport of biodiesel fuel to the point of use

- Use of the fuel in a diesel engine. This last stage is where there is much concern about impacts on local air quality, toxic emissions, and greenhouse gas emissions.

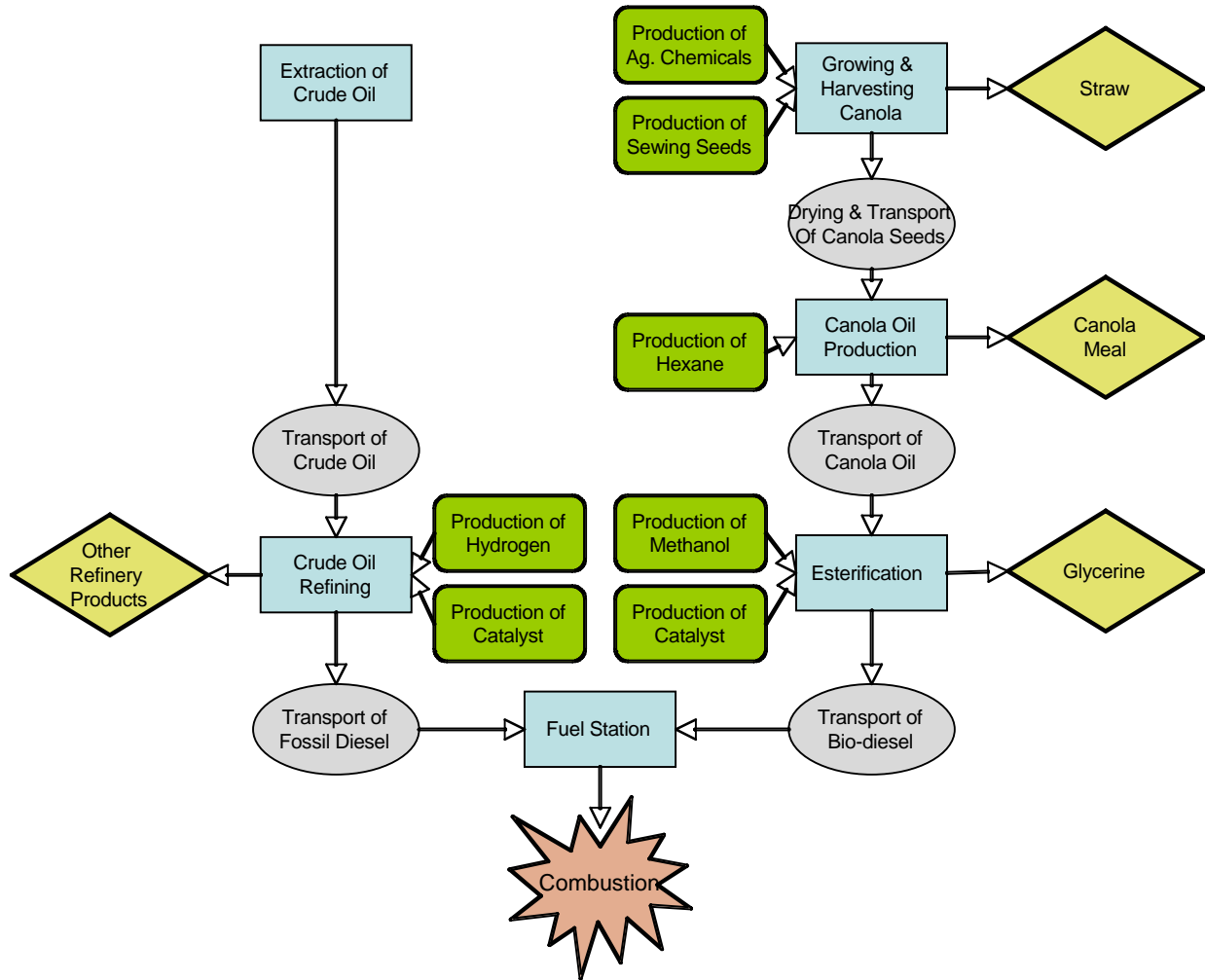

Figure 1-1 Comparison of fossil-diesel and biodiesel life cycles from "well to wheel."

The geographic focus of this study is limited to the use of petroleum diesel and biodiesel in Canada. Where data from Canadian process steps were not available information from equivalent US facilities and processes were used. In general however, Canadian industry averages have been employed except where regional differences are significant and highlight geographically distinct outcomes within Canada.

1.2 Scope and objective

The objective of this report is to evaluate how the use of biodiesel instead of fossil diesel will impact the environment and how much GHG reductions can be achieved by switching from 100% fossil diesel to a biodiesel blend in a Canadian context. In this synthesis there will be a focus on:

- Greenhouse gas emissions

- Water use and quality and land use – addressing commonly expressed concerns about the use of agricultural crops for energy such as
- Fertilizer use and production
- Herbicide and pesticide use and production
- Consumption of energy and resources
- Air quality – addressing the concern that biodiesel may exacerbate air quality particularly in terms of nitrogen oxide emissions
- Accidents/spills – where differential impacts from accidental spills biodegradation, solvent issues and other relevant events are addressed
- Human health

The report will review lifecycle evaluations of using biodiesel to replace fossil diesel and will differentiate between canola and the following other fuel sources:

- Soy
- Tallow/animal fat
- Ethanol
- Fossil diesel

The findings reflected in this report are based on a number of papers and existing LCA tools. We relied heavily on GHGenius^{7, 10} an LCA model developed for the National Research Council. This model builds on the foundations of DeLucci's Lifecycle Emissions Model⁵⁹ but using modified inputs and production information reflecting Canadian conditions.

In this review we rely heavily on three major reports on biodiesel LCAs. These reports differ in some aspects of methodology and in the exact boundaries of their analysis. These are summarised in Table 1-1. Where possible we draw attention to how these differences have led to divergent findings. In other places, their divergence arises from differences in assumed emission rates. We return to a discussion of key uncertainties and methodological challenges in the final chapter of this report.

Table 1-1 LCA methods and boundary comparisons

	Geography	System boundary	Allocation	Biodiesel production	Electricity generation
Rollefson	Canada & US data where local data unavailable	Excludes animal production for tallow and vegetable oil production for used cooking oil	System expansion	BIOX process	Canadian generic for electricity, plus oil & gas for agrochemicals
(S&T) ²	Canada, using GHGenius	Same as above	System expansion	A choice of system parameterisations for trans-esterification & high free fatty-acid	Canadian generic for electricity, plus oil & gas for agrochemicals

				feedstocks	
Sheehan	US focus	Use of petroleum diesel and biodiesel in the US	Mass allocation	Trans-esterification	Modeled as a national average for the US national basis.

2 On Farm Operations & Environmental Impacts

2.1 Introduction

Canola and soybeans provide the primary agricultural feedstocks for biodiesel production in Canada. This section will detail the energy and materials requirements and associated environmental impacts for agricultural production of canola and soybeans. A number of references will be used to provide canola and soybean agricultural data. These references include "Assessment of the Environmental Performance and Sustainability of Biodiesel in Canada" prepared by Rollefson, Fu and Chan of the National Research Council (NRC) in 2003, and "Biodiesel GHG Emissions Using GHGenius: An Update" prepared for the NRC by (S&T)² Consultants in 2005. Beer (2001) also published a study focussed on canola biodiesel reflecting Australian conditions.

2.2 Production & Yield

Canola has the greatest potential to meet growing demand for biodiesel production, as it represents on average two thirds of Canada's total oilseed production ⁴. The majority of canola production in Canada occurs in the Prairie Provinces Alberta, Saskatchewan, and Manitoba, with limited additional acreage in British Columbia, Ontario, and Quebec. In the most recent year with available data (2004-05), Canadian canola seed production totalled 7,728,000 Tonnes (Source: Statistics Canada and COPA monthly cited in ³), with 4.94 million Ha (Source: Field Crop Reporting Series - Statistics Canada cited in ³) under cultivation. Soybeans are Canada's second largest oilseed crop, and in contrast to canola, are grown predominantly in Ontario and Quebec, with small additional acreage in Manitoba and the Maritimes ⁴. In 2004-05, Canadian soybean production totalled 2,920,00 tonnes with 1.23 MHa under cultivation (Sources: Statistics Canada, OMAF, Agriculture and Agri-food Canada and Ontario Soybean Growers as cited in ¹²). The following table provides historical Canadian yield data for both canola and soybeans.

Table 2-1 Canadian Canola and Soybean Yield Data 1995 - 2005 ^{2,3}

Year	Total Canola Production (MT)	Canola Yield (T/Ha)	Total Soyabean Production (MT)	Soyabean Yield (T/Ha)
1995	6.43	1.2		
1996	5.06	1.5		
1997	6.39	1.3		
1998	7.64	1.4	2.7	2.8
1999	8.80	1.6	2.8	2.8
2000	7.21	1.5	2.7	2.6
2001	5.02	1.3	1.6	1.6
2002	4.52	1.2	2.3	2.3
2003	6.77	1.4	2.3	2.2
2004	7.73	1.6	2.9	2.4

2005	9.66	1.8		
------	------	-----	--	--

It is important to note that for the 2005 crop year, 1,629,000 tonnes of Canadian canola production were carried over to the following year without being crushed or exported³. It is estimated that for the 2006 crop year, this “ending stock” of canola will rise to slightly more than 2,000,000 tonnes. Therefore, Canadian canola growers are more than capable of meeting a significant demand for biodiesel feedstock with little or no impact on the supply of canola for edible oil and export.

As detailed by Rollefson et al.², the primary determinant of year on year canola yield is the level of rainfall in the Prairies. This is because canola is primarily grown using “dryland” farming methods, meaning that no irrigation is used to supplement natural rainfall. The primary determinants of soybean yield include available moisture (from rainfall and / or irrigation), soil type (clay or loam), and available heat units. The poor yield for soybeans in 2001 shown in Table 2.1. above was attributable to both lack of rainfall and a coincident aphid infestation.

Important additional factors to consider regarding yield include the average oil content of the produced seed, and the percentage of yearly production required as seed for following year’s planting. Table 2.2 provides details regarding oil content and seed requirements. Note the significantly lower oil content of soybeans, and the significantly larger seed requirement as a percentage of total production. These factors somewhat offset the fact the soybean yields can be twice as high as canola. However, it should be noted that low oil content also means a larger mass of non-oil material (mostly protein meal) that is not useable in biodiesel production.

With a canola-oil based biodiesel industry, the market for protein meal will respond to greater availability. There are seed varieties in development with more oil production and less protein content (the current target is 2%) and fully fledged bio-refinery of canola is part of the industry’s long term plans.

Table 2-2 Canadian Canola and Soybean Oil Content and Seed Requirements ^{4, 5}

	Average Oil Content (%)	Seed Requirements (kg/ha)	Seed Requirements (% total production)
Canola	42	6.7	0.5
Soybeans	18.4	100	4.2

2.3 Materials Consumption

The primary inputs materials inputs required for canola and soybean production include seed, fertilizers, and agrochemicals, each of which will be addressed individually in the following sections.

2.3.1 Seed

Seed requirements were addressed briefly in the Production and Yield section, but it is important to discuss a strong trend in both canola and soybean agriculture. The development of herbicide resistant (HR) varieties of canola and soybeans has led to

profound changes in agricultural practices. According to the Canadian Canola Council, in 2005 96% of canola fields were planted with HR seed varieties. The primary rationale for the use of HR seed varieties is their resistance to herbicides or combinations of herbicides, which in turn allows producers to more effectively control competition from weed species.

The use of HR seed and associated herbicides often goes hand-in-hand with “conservation tillage” farming practices designed to minimize soil disturbance and limit erosion. The United States Department of Agriculture defines conservation tillage as follows:

“Conservation Tillage is a term that covers a broad range of soil tillage systems that leave residue cover on the soil surface, substantially reducing the effects of soil erosion from wind and water. These practices minimize: nutrient loss, decreased water storage capacity, crop damage, and decreased farmability. The soil is left undisturbed from harvest to planting except for nutrient amendment. Weed control is accomplished primarily with herbicides, limited cultivation, and, in more sustainable systems, with cover crops”¹³.

As discussed in the following sections, conservation tillage regimes and HR seed varieties are significantly changing the nature of canola and soybean agriculture.

2.3.2 Fertilizers

In order to ensure consistent yields, canola has relatively intensive fertilizer requirements, particularly for nitrogen. In contrast, soybeans are nitrogen-fixing legumes, and thus can typically meet their own nitrogen requirements. Fertilizer requirements for both canola and soybeans are typically tied to soil type, variety planted, and expected yield (based on expected rainfall and heat units). However, detailed analysis of factors affecting fertilization is beyond the scope of this document. Both Rollefson et al ² and (S&T)⁴ provide significant additional detail on canola and soybean fertilization.

Table 2.3 provides a comparison of typical canola and soybean fertilizer requirements, with data taken from a Canola Council producer survey from 2001, and the Manitoba Agriculture guideline for soybean production. Note that soybean requirements for P, K, and S fertilizers per hectare are higher than those for canola, but once these figures are normalized for yield, except for phosphorus, they are not dramatically different. As also shown in the table, soybeans typically do not require any N fertilizer, but do require inoculation with nitrogen fixing bacteria (*bradyrhizobium japonicum*) to ensure adequate fixing rates.

Table 2-3 Canadian Canola & Soybean Fertilizer Requirements ^{4, 6}

	Herbicide Resistant Canola	Conventional Canola	Soybeans
Nitrogen Kg/ha	75.5	71.3	None (inoculate)
Phosphorous Kg/ha	26.6	25.3	34-45
Potassium Kg/ha	6.3	4.9	34-68

Sulphur Kg/ha	13	11.8	22
Average Yield, T/ha	1.6	1.5	2.5

Because soybeans typically fix more nitrogen into the soil than they consume during growth, producers experience a “credit” of excess nitrogen that can be utilized by crops grown the year after soybeans. According to Rollefson², this credit has been determined to be on average 7kg(N)/tonne yield of soybeans. This becomes important when considering the amount of nutrients removed from the soil by canola and soybean crops. In order to maintain a sustainable year on year crop performance, the nutrient addition through fertilizer or natural nitrogen fixation must offset the nutrients removed when the crop is harvested. The following table compares the typical nutrient removal rates of canola and soybeans, assuming that all plant matter other than grain is returned to soil when harvested.

Table 2-4 Canadian Canola and Soybean Soil Nutrient Removal Rates ⁴

	Canola Removal Rate Kg/ha	Canola Removal Rate kg/T	Soybean Removal Rate Kg/ha	Soybean Removal Rate kg/T
Nitrogen	68-83	35-42	209-224	63-67
Phosphorous	37-45	19-23	45-50	13-15
Potassium	18-23	9-11	77-78	23
Sulphur	11-13	6-7	5.6	2
Average Yield, T/ha	1.96		3.36	

As indicated in table 2-4, soybeans are a very nitrogen intensive crop. Their ability to fix nitrogen naturally is extremely important for sustainable soybean production, because artificial nitrogen addition rates for soybeans would be extremely high without the nitrogen provided by natural fixing.

2.3.3 Agrochemicals

Both canola and soybean agriculture depend strongly on the use of herbicides to control competition from weed species, pesticides to control outbreaks of insects such as Flea beetles and aphids, and fungicides to control outbreaks of root and stem rot (sclerotinia and blackleg in canola). These agrochemicals represent significant inputs to the canola and soybean agricultural systems, because they may strongly affect expected crop yield, and because the energy and material inputs required in manufacture of these chemicals can be large.

The development of genetically modified herbicide resistant (HR) varieties of canola and soybeans has led to profound changes in typical agricultural methods. According to Rollefson¹, in 2002 75% of US soybean crops employed HR varieties, while HR canola is reckoned to account to 80-85% of Canadian canola plantings. Crop resistance to broad spectrum herbicides such as glyphosate and glufosinate has allowed a move to conservation tillage techniques that significantly reduce the amount of soil disturbance, thus reducing the necessary fuel required for tillage while also reducing soil erosion.

Further discussion of fuel savings attributable to conservation tillage is presented below in the Energy section.

Figure 2-1 provides further data regarding the percentage of herbicides applied to canola crops in Canada from 1995 – 2005. During this period, the use of HT canola increased dramatically, accompanied by a rise in applicable herbicides. At the same time, use of conventional canola seed decreased, and with it, conventional herbicide use. During the period shown in the graph, the move to HT canola resulted in an overall

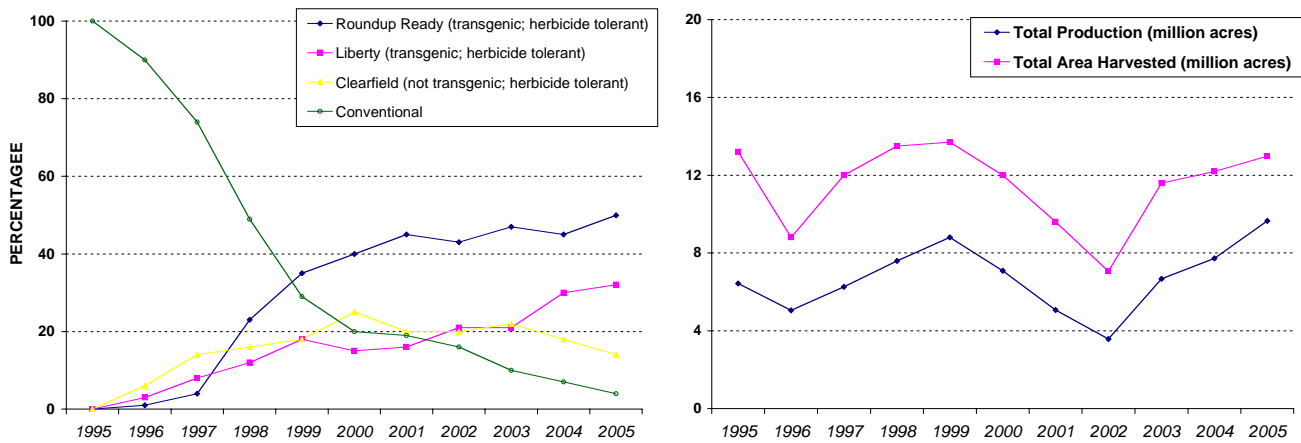

reduction in the total amount of herbicide used, largely because the broad spectrum herbicides associated with HT canola negate the need for producers to use multiple herbicides to deal with different weed species.

Figure 2-1 Estimated acreage, production, and percentage of Herbicide Tolerant (HT) and Conventional Canola in Canada

Percentages estimated from provincial databases, seed company information and surveys. Harvested acres and production are from Statistics Canada

A 2001 published survey of 650 Canadian canola producers gathered comparable data on the use of herbicides, insecticides and fungicides, and the average number of field operations carried out to apply the chemicals. Not surprisingly, 100% of surveyed farmers growing HR canola have applied herbicide, because the main rationale for using these varieties is their engineered resistance to a particular herbicide. The percentage applying insecticides and fungicides are roughly equivalent in HR and conventional seeds (10% for insecticide, 14-16% for fungicides), likely because these chemicals are not typically required unless there is a beetle or fungus outbreak⁹.

Regardless of the trend towards decreasing herbicide volumes, it is important to recognize that the production and use of agrochemicals are associated with environmental impacts. These are taken up separately in the Emissions and Environmental Impacts section below.

2.4 Energy and Equipment Use

Direct energy inputs for canola and soybean agriculture typically consist of diesel fuel, gasoline, and electricity, which are used to power farm equipment, run irrigation

pumps, and power transportation equipment that moves harvested seed from the field to farm storage. Indirect energy inputs include energy associated with the manufacture of fertilizers and agrochemicals. Because production of fertilizer is so highly energy intensive, the single largest energy input in canola agriculture (74-79% depending on tillage method) is fertilizer production energy, with the energy required for field operations coming a distant second (14-21% depending on tillage method)². Table 2-6 provides data from Lindwall et al. as cited in Rollefson² for conventional till and conservation (zero) till canola and field peas. Soybean data were not available from this reference, but since field peas are nitrogen fixing in the same way as soybeans, they provide a reasonable point of comparison. As such, the percentage of total energy input attributable to non-nitrogen fertilizer manufacture for soybean production is expected to be in line with the data shown for peas.

Table 2-5 Total Energy Inputs & Outputs for Conventional and Conservation Tillage Canola and Field Pea Production (MJ/ha)

Input	Conventional Tillage Canola	Conservation Tillage Canola	Conventional Tillage Field Peas	Conservation Tillage Field Peas
Seed	92	99	610	580
Fertilizer	6650	7400	2270	2170
Herbicide	385	520	250	540
Field Operations	1900	1330	1770	1250
Total Input	9030	9360	4900	4550
Total Output	29600	29750	28800	31300
Net Energy gain (%)	228%	218%	488%	588%

The table reflects two key issues: a) the significant extra energy input required for canola because all nitrogen requirements must be met through fertilizer addition, and b) the fact that conservation tillage regimes do not significantly reduce the total energy required for canola and soybean agriculture. Also note that the data in the table reflects the significantly larger seed requirements for peas and beans already highlighted previously.

Diesel fuel for tillage represents the most significant direct energy input in both canola and soybean production. A wide range of data for fuel usage is available, but some of the most recent data presented in (S&T)⁴ indicates that the Saskatchewan Canola Production Guide provides an estimate of 37 – 52 L/ha for canola, while a 2002 USDA report indicates an estimate of 38 L/ha for soybeans.

2.5 Emissions & Environmental Impacts

2.5.1 Energy Emissions

Energy emissions encompass all by-products of the direct and indirect energy inputs required for canola and soybean agriculture. Because the largest energy inputs derive from the combustion of fossil fuels, energy emissions are typically accounted in terms of

CO₂ equivalent greenhouse gas emissions and other combustion products. As discussed previously in the Energy and Equipment Use section, fertilizer production represents the single largest energy input for both canola and soybeans, and as such, also represents the largest source of energy emissions.

Despite the wide range of literature available regarding the energy requirements of fertilizer production, there is little agreement on energy required (and hence the magnitude of the emissions) to make fertilizer, particularly nitrogen fertilizers. Extensive discussion of the energy requirements for fertilizer production can be found in Rollefson et al² and Sheehan et al⁵. The following table presents data from Rollefson et al² details a range of estimates for the natural gas requirements of N fertilizer production, along with the associated amount of CO₂ equivalent greenhouse gas emissions released per kilo of canola produced. The table does not contain data for soybeans, because it is assumed that no N fertilizer is applied during Soybean agriculture.

Table 2-6 GHG Emissions from N-fertilizer usage in Canola Agriculture ²

Natural gas requirements for N-fertilizer production	GHG in Fertilizer Production kgCO ₂ -eq/ tonne canola produced	GHG Emissions as N ₂ O from Fertilizer Application kgCO ₂ -eq/ tonne canola produced (IPCC estimates)	Total GHG Emissions kgCO ₂ -eq./ tonne canola produced
53 MJ/kg(N)	135	560	695
61.9 MJ/kg(N)	137	560	697
76.1 MJ/kg(N)	140	560	700

Note that one of the most important features of the data in Table 2-6 is the lack of variation in the Fertilizer kgCO₂-eq / tonne canola across the range of natural gas requirements values. Also note that the GHG emissions associated with N fertilizer production represent only 20% of the total GHG emissions. As discussed further below, by far the largest source of GHG emissions associated with canola and soybean agriculture is evolution of nitrogen oxide compounds, particularly nitrous oxide (N₂O), directly from fields as a result of nitrogen fertilizer breakdown. However it should be noted that no wide consensus has been reached on the amounts of N₂O emissions and as discussed under the NO_x and N₂O emissions from the soil section (section 2.5.4.), in some studies experimental data for canola indicate emission rates less than one third those presented in table 2-6.

Figure 2-2 from Agriculture and Agri-food Canada¹² provides a comparison of US natural gas prices, and the price of anhydrous ammonia (precursor to all nitrogen fertilizers) in Alberta. This may seem like a strange association, but US natural gas prices define the opportunity cost of gas in Alberta and hence a key factor in the price of anhydrous ammonia produced there using natural gas. The figure has two important features: a) a period of high ammonia prices between 1995 and 1999 when production capacity was limited; b) a period of volatile prices following the ups and downs of

natural gas prices starting in 2000. Today, the price of anhydrous ammonia is more than twice what it was in 1991.

With natural gas prices expected to remain above historic levels, nitrogen fertilizer prices are also expected to remain high. The main implication of high fertilizer prices is an increase in the cost of production for highly nitrogen fertilizer intensive crops such as canola. However, this may have a positive impact with respect to fertilizer application, because high prices will encourage farmers to adopt the most efficient and effective fertilizer application regimes¹⁴. As detailed in the following section on nitrous oxide emissions, over-application of nitrogen fertilizers may lead to increased greenhouse gas emissions from agricultural fields.

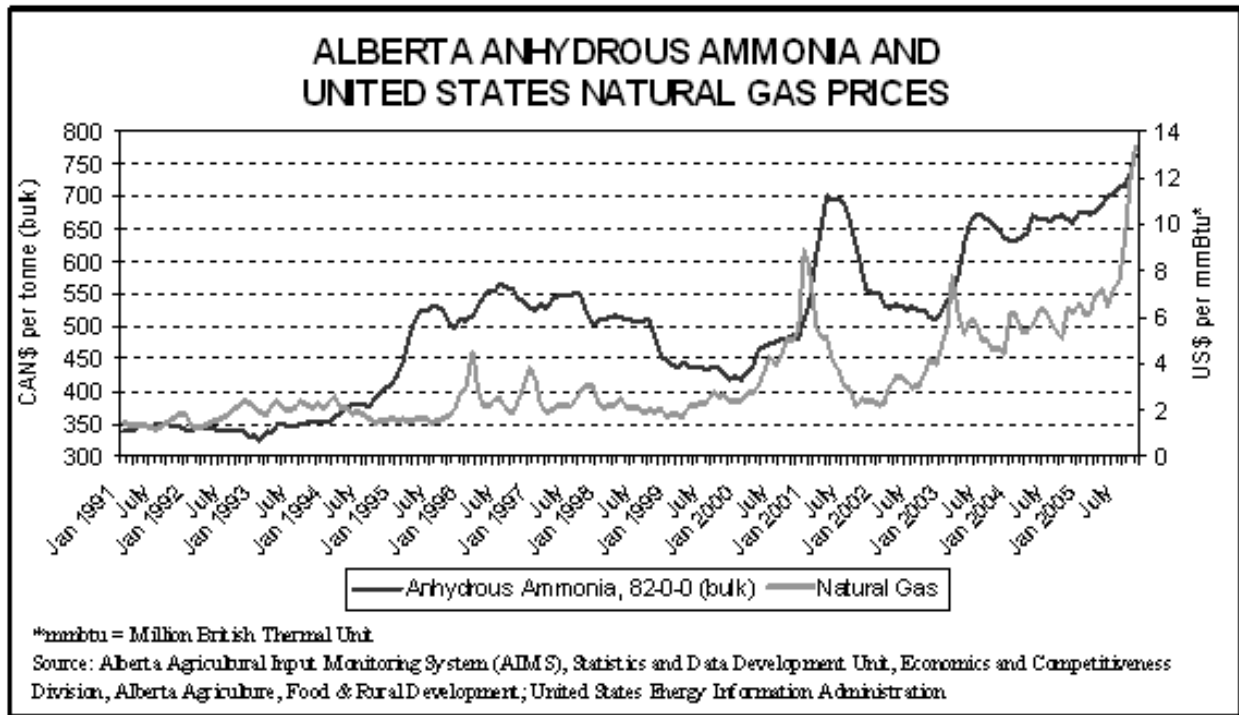

Figure 2-2 Rising price of gas has pushed up the price of anhydrous ammonia¹⁵.

Aside from fertilizer production, the second largest source of energy emissions associated with canola and soybean agriculture is the combustion of fuel during field operations. As herbicide resistant varieties of canola and soybeans allow producers to move to conservation or zero tillage regimes, the direct field energy requirements (and hence energy emissions) are significantly reduced because less equipment use is required. However, as highlighted previously in the Energy and Equipment Use section, these gains are offset by the additional needs for energy and emissions intensive fertilizers and agrochemicals. The following table from Rollefson et al² compares the energy inputs and emissions from conservation and conventional tillage schemes for canola, highlighting small difference in total GHG emissions.

Table 2-7 GHG Emissions Comparison for Conservation and Conventional Till for 1 tonne canola produced ²

Tillage Scenario	Field energy requirements - diesel consumption	Field Energy kgCO ₂ -eq/tonne canola produced	Total kgCO ₂ -eq./tonne Canola produced (IPCC est.)	Total kgCO ₂ -eq./tonne Canola produced (field obser.)
Conservation till	37 L/ha (31.4 kg/ha)	28.2	682	250
Conventional till	54 L/ha (46.5 kg/ha)	41.8	696	264

Given the data above, it is clear that the primary advantage of conservation tillage is the protection of soil from erosion and nutrient leaching rather than reduction of overall energy inputs and associated emissions. But the difference between conventional tillage and IPCC emission rates and conservation tillage with observed N₂O emissions in Canada yields a total GHG emission difference of more than 175%.

2.5.2 Soil Carbon Sequestration

Soil Organic Carbon (SOC) is one of the important sources for carbon(C) storage and exchange with atmospheric CO₂. Practices which increase residue and plant growth increase SOC sequestration. Examples of such practices are the use of conservation tillage (i.e., no-till, ridge-till, and mulch-tillage), maintaining higher levels of residue cover on conventionally tilled cropland, planting cropland to permanent cover, and improved fertility management. Observations by Reicosky et al. as cited in (16 Follett,R.F.) strongly indicate that mechanical disturbance of soil by tillage increases the decomposition of SOC. 16 Various studies indicate that a change from conventional tillage (CT) to no-till (NT) results in an increase in soil carbon content. Tristram and Wilfred found that such a change can sequester an average of 57 ± 14 grams of carbon per square meter per year.17 It is clear that such carbon sequestration rates are unlikely to hold for the long run. Hence, long-term studies were initiated. In a comparison of 39 paired tillage experiments ranging in duration from 5 to 20 years, Paustian et al. 18, estimated that NT resulted in an average soil carbon increase of 285 grams per square meter with respect to CT. Considering an average experiment duration of 13 years implies an approximate carbon sequestration rate of 22 grams per square meter per year. Using the average yield of canola in Canada from 1995-2005, this translates into an average annual soil CO₂ sequestration of 562kg/Ha.

Revisiting Table 2-7 we can now recalculate the net GHG emissions associated with canola production with both observed N₂O emission rates and the impact of conservation tillage. As shown in Table 2-8, these two factors alone change the picture of GHG emissions from emitting almost 700kg of CO₂eq GHGs per tonne of canola produced to one of taking almost one third of a ton of carbon out of the atmosphere for each tonne of canola produced.

Table 2-8 GHG Emissions Comparison for Conservation and Conventional Till for 1 tonne canola produced

Tillage Scenario	Field energy	Field Energy	Total kgCO ₂ -	Including Soil
------------------	--------------	--------------	---------------------------	----------------

	requirements - diesel consumption	kgCO ₂ -eq/tonne canola produced	eq./tonne Canola produced (field obser.)	carbon sequestration
Conservation till	37 L/ha (31.4 kg/ha)	28.2	250	-312 ±140
Conventional till	54 L/ha (46.5 kg/ha)	41.8	264	-298 ±140

2.5.3 Agrochemicals

As previously detailed, agrochemical usage in canola and soybean production accounts for a significant portion of the indirect energy and materials inputs, and strongly influences direct energy inputs through the enabling of conservation tillage. However, despite the energy implications of agrochemical usage, the largest concerns associated with chemical usage revolve around the effects of emissions to air, soil and water.

Owing to the current prevalence of herbicide resistant canola and soybeans varieties, the most commonly used agrochemicals for both crops are the broad spectrum herbicides glyphosate and glufosinate. Both herbicides are widely used and significant research exists regarding their emissions profiles. Both glyphosate and glufosinate have very low vapour pressures², meaning that significant volatilization of the applied chemicals to the air is low, estimated to be 2% of total active ingredient applied per hectare. However, the breakdown products of both chemicals are water soluble, and are readily transported by runoff into bodies of water adjoining fields where the chemicals have been applied. Particularly for glufosinate, research indicates that breakdown products may be toxic to waterborne zooplankton².

Many ecologists have voiced concern that the genetic traits that confer herbicide resistance to HR canola can be passed on to other species. A mechanism used in the laboratory (viral infections) is also active in the field, but certainly not as selective. Such an event would confer herbicide resistance properties to competing species and necessitate a new round of innovations in coupled seed-herbicide engineering. There is no evidence of herbicide resistant weeds in Canada. But the theoretical possibility of their emergence cannot be denied.

2.5.4 N₂O Emissions from Soil

As indicated in literature detailing the sustainability of canola and soybean agriculture, one of the most significant concerns is the emission of nitrogen oxide compounds from the soil during and after crop growth. Nitrous oxide (N₂O) has a large infrared radiation trapping coefficient (also known as global warming potential compared to carbon dioxide (estimated at anywhere from 251¹⁹ to 310 times² greater than CO₂). This means that even small quantities of nitrous oxide emitted from the production of biofuels can dramatically reduce their net beneficial impact on mitigating climate change. Animal and crop production are estimated to account for 70% of the total man-made nitrous oxides emissions worldwide²⁰. At current concentrations, N₂O is estimated to account for 5% of the total atmospheric greenhouse effect.

The estimation and measurement of nitrogen oxide emissions from agriculture is fraught with difficulty, and the available literature shows a wide range of emission rates from canola and soybean agriculture.

The most common reference point for emission rates is the United Nations Intergovernmental Panel on Climate Change (IPCC) which has developed a widely used methodology for estimating agricultural emissions of a variety of greenhouse gases, including nitrous oxide. The IPCC methodology indicates that the predominant source of N₂O emissions from both canola and soybean agriculture are “direct soil emissions”, which arise from the bacterial decomposition (nitrification and denitrification) of nitrogen compounds in the soil into nitrous oxide. According to the IPCC, the sources of direct soil emissions are:

- Synthetic nitrogen fertilizer applied
- Nitrogen in crop residue returned to soils
- Nitrogen fixed by N-fixing crops
- Animal waste (manure) fertilizer applied

With respect to the application of synthetic fertilizer, the IPCC methodology does not distinguish between different crop varieties, but simply estimates that 1.25% by mass of all nitrogen applied as synthetic fertilizer will be re-emitted as nitrous oxide. Experimental data from a wide variety of crop types and locations in Canada indicate an average emission rate of 1.18% of synthetic nitrogen applied²⁰, which agrees well with the IPCC estimate. The nitrous oxide emissions rate due to natural nitrogen fixing by crops such as soybeans was initially estimated by the IPCC to follow exactly the same relationship as synthetic fertilizer application (emissions of 1.25% of total nitrogen fixed). However, experimental data indicates that there may be no direct relationship between the rate of natural nitrogen fixation and nitrous oxide emissions rate²¹. Instead, data indicate the primary source of nitrous oxide emissions from nitrogen fixing crops to be the decomposition of high nitrogen crop residues during and after crop growth. This is an area where the IPCC methodology and data are in need of significant revision.

Estimates of nitrous oxide emissions from crop residues returned to the soil are problematic, because crop residues vary widely in nitrogen content. As such, the IPCC methodology contains crop specific emissions factors which are based on total crop yield. Using Agriculture Canada’s revised IPCC guidelines ², the nitrous oxide emissions due to crop residue are 0.045% by mass of total soybean yield, and 0.025% by mass of total canola yield. However, the factor given for soybeans pre-dates the findings of Rochette and Janzen ²¹ as mentioned above, so it’s use in calculations may result in lower than observed nitrous oxide emissions values.

The other possible source of direct soil emissions of nitrous oxide is the decomposition of natural fertilizer such as animal waste. Again, the IPCC methodology proposes a simple linear relationship between the total nitrogen applied as natural fertilizer and the nitrous oxide emissions rate. Unfortunately, experimental data from Canada and abroad²⁰ indicate that observations do not support the IPCC methodology. High nitrous oxide emissions rates have been documented from fields where animal manure is used as

fertilizer²⁰, but the relationship between natural fertilizer application rates and nitrous oxide emissions rates have been observed to be tenuous at best.

The vast majority of canola and soybean grown in Canada uses artificial fertilizers, so the subsequent discussions will assume that artificial fertilizer, nitrogen fixation, and residue decomposition are the sources of nitrous oxide emissions.

For canola, the largest source of nitrous oxide emissions is the decomposition of artificial nitrogen fertilizers, while for soybeans the most significant source is decomposition of high nitrogen crop residues during and after crop growth. According to Rollefson et al², the production of soybeans emits 35% of the nitrous oxide per unit yield that is emitted during canola production (based on the Agriculture Canada adjusted IPCC methodology). However, it is also stated that nitrous oxide emissions still represent 85% of the total effective greenhouse gas emissions from soybean production. It should be noted that some analyses of soybean agriculture (notably Delucchi ^{19, 22}) estimate much higher nitrous oxide emissions rates than those given by Rollefson et al². The sources of this disparity and the contradictions with field observations in Canada are not clear.

The following table presents Agriculture Canada Adjusted IPCC nitrous oxide emissions estimates for both canola and soybeans, as well as measured data for canola grown in Saskatchewan from Rollefson et al². Other available Canadian data from Rochette and Janzen²¹ indicate measured soybean N₂O emissions rates ranging from 290 g/ha to 3860 g/ha, with an average observed emissions rate of 1352 g/ha.

Table 2-9 Canola and Soybean N₂O Contribution to GHG Emissions ²

Crop / Scenario	Method	N ₂ O emission (g/ha)	N ₂ O emission (kgCO ₂ -eq/tonne production)	Total (kgCO ₂ -eq./tonne production)
Canola	IPCC adjusted	2158	478	552
	Experimental Data	211	46	120
Soybean, N credit due to fixation	IPCC adjusted	879	165	185
Soybean, no N credit due to fixation	IPCC adjusted	1170	219	259

As indicated by the data in Table 2-9 above, N₂O emissions represent the largest single GHG source for both canola and soybean production. Unfortunately, the lack of agreement between IPCC estimates and experimental measurements for canola grown in the arid conditions prevailing in western Canada lead to significantly different emission figures than those often reported. Furthermore, there appears to be an

inconsistency in the Rollefson et al study of this issue, even though they point out the differences between observed field emission rates and IPCC emission inventory methodology. Significant further discussion of canola and soybean nitrogen oxide emissions and the associated research to quantify them can be found in a number of sources, including Sheehan et al⁵, Rollefson et al², Delucchi¹⁹, Rochette and Janzen²¹, and Helgason et al²⁰.

Given that nitrous oxide emissions play such a significant role in increasing overall greenhouse gas emissions from canola and soybean agriculture, it is important to consider possible emissions mitigation options. A variety of research has been carried out in Canada and worldwide to investigate the effects of tillage practices, the timing of fertilizer application, the use of winter cover crops, and the use of nitrification inhibitors. Perhaps not surprisingly, there is no more agreement between the various results of this research than there is in the quantification of nitrous oxide emissions.

Because of strong dependence on soil characteristics and climate, particularly available soil moisture, nitrous oxide emissions may differ significantly from year to year and area to area under the same fertilizer application and tillage regimes²⁰. For instance, it has been observed that conservation tillage practices decrease N₂O emissions in arid Prairies growing regions where soil moisture is typically low, while increasing emissions in the more humid growing regions of Eastern Canada where soil moisture is typically high²⁰.

In highly seasonal climates such as those in most of Canada, the most significant nitrous oxide emissions are typically observed during freeze thaw cycles that occur during winter and early spring months²³. As a result, soils with higher nitrogen content prior to the onset of the freeze thaw cycles typically exhibit higher nitrous oxide emissions during the early spring. Wagner-Riddle and Thurtell²³ explore this phenomenon in detail, and conclude that fall fertilizer application, fall incorporation of high nitrogen crop residue, and fall fallow tillage all increase early spring nitrous oxide emissions, while the use of winter cover crops (grass or alfalfa) significantly reduce nitrous oxide emissions.

Delucchi ¹⁹ discusses the use of nitrification inhibitors that partially block the activity of the natural bacteria causing the breakdown of soil nitrogen compounds into nitrous oxide. Results presented indicate a reasonable level of success in reducing nitrous oxide releases, but also indicate that other natural bacterial processes such as the uptake of methane through bacterial processes may be blocked by the inhibitors, leading to increased methane emissions (another potent greenhouse gas).

In conclusion, there are opportunities to reduce nitrous oxide emissions through the use of fertilizer application and crop management practices that are carefully matched to the growing conditions for a given soil and climatic region. However, there is still significant uncertainty in the effects of a wide variety of natural and human-controlled factors surrounding agricultural nitrous oxide emissions. Research in the area is ongoing, but for the foreseeable future, these emissions will remain the largest greenhouse gas contribution from the agricultural production of canola and soybeans.

2.5.5 Soil Erosion

Soil erosion refers to loss of soil mass from fields, primarily driven by wind and water flow. Not only does erosion remove soil mass, but also accounts for the transport of natural and artificial nutrients (fertilizers) and agrochemicals off fields and into the atmosphere and waterways. Availability of current data for the erosion associated with Canadian canola and soybean production is poor, possibly because tillage practices have shifted dramatically in recent years due to the increase in the use of herbicide resistance varieties.

Sheehan et al⁵ provides soybean erosion data from the early 1990s in for a number of US states. For the most northerly states (Minnesota and Ohio), water erosion was estimated to account for the loss of 7.2 T/ha of soil for soybean growing, against an average of 6.7 T/ha for all crops. Wind erosion was shown to be very significant in some northern areas (9.4 T/ha for Minnesota) and virtually negligible in others (0.45 T/ha in Ohio). It is expected that the move to conservation tillage techniques have resulted in significant reduction in erosion rates over those presented above.

2.5.6 Water Use

In Canada canola is typically grown using available moisture. In a 2000 survey of 650 producers, only 1% of respondents indicated that they irrigated their canola crops⁹. Soybeans however, are grown under both dry land and irrigated conditions. Irrigation data were not available for Canadian soybean production, but Sheehan et al. provide irrigation rates of 1.2-1.8 M litres/Ha/Yr for soybean production in northern US states (1994)⁵.

Table 2-10 provides a selection of crops that can be used to make biodiesel, along with the “virtual water content” (or volume of water required per kg crop yield). The table also contains data for the average biodiesel yield and production fraction from each crop, facilitating the calculation of the volume of water related to crop production required for to make a litre of biodiesel from each listed crop. Because canola and soybeans grown in Canada receive little or no irrigation, the data in table for these crops represents the natural water required for crop growing, as well as all other water inputs required for all materials and energy required for crop growing, including fertilizer production and energy (diesel fuel, etc) production.

Table 2-10 Agricultural Water Efficiency of biodiesel production by crop

CROP	Crop Yield kg/ha	Water Used for crop production L/kg	Biodiesel Yield L/Kg of Crop	Biodiesel per Hectare L/ha	Product Fraction	Water (L) per litre of Biodiesel
Canola	1540 ^{24, 25}	1765 ²⁶	0.43 ²⁴	664	0.4 ²⁷	1638
Castor	2466 ²⁴	9807 ²⁶	2.27 ²⁴	5605	0.4 ²⁶	1726
Coconut	3060 ²⁸	3031 ²⁶	0.40 ²⁴	1224	0.36 ²⁶	2728
Cottonseed	1045 ²⁴	2535 ²⁶	0.21 ²⁴	215	0.16 ²⁶	1971
DOE Mustard Hybrids	3095 ^{24, 25}	1012 ²⁶	0.43 ²⁴	1340	0.38 ²⁶	888

Mustard (spice)	1042 ^{24, 25}	1012 ²⁶	0.43 ²⁴	449	0.38 ²⁶	892
Peanuts	3393 ²⁴	1797 ²⁹	0.27 ²⁴	917	0.43 ³⁰	2859
Rapeseed	1464 ²⁴	1765 ²⁶	0.43 ²⁴	637	0.37 ³¹	1502
Safflower	1650-2200 ²⁴	1976 ²⁶	0.27 ^{24, 32}	444-591	0.32 ³⁰	2352
Soybean	2663 ¹²⁴	1203 ²⁶	0.20 ²⁴	524	0.18 ²⁶	1100
Sunflower	1530 ^{24, 25}	1543 ²⁶	0.26-0.43 ^{24, 33}	398-662	0.41 ²⁶	1461-2480

Note that water volumes in the table have been allocated to biodiesel on a mass-fraction basis, meaning that the other co-products from oil / biodiesel production (typically protein meal from oilseed crushing) are allocated a portion of the total water consumption proportional to their mass. This may produce slightly misleading results, because for crops like soybeans with a low oil content, much of the water volume required for growing ends up allocated to the meal co-products (which may be of lower value and in less demand than biodiesel), whereas for higher oil content crops such as canola, oil / biodiesel ends up with a higher water allocation. Under this mass allocation assumption, soybeans end up appearing as one of the most water efficient sources of biodiesel, while canola appears to require 50% more water, probably largely due to water required for nitrogen fertilizer production.

If the assumptions are adjusted, and the co-products of biodiesel production are assumed to have no value or use (probably unnecessarily harsh), a full allocation of all water use directly to biodiesel shows better results for canola. Total water per litre of biodiesel for canola is 4105L, and for soybeans is 6015L, almost 50% higher. In this case, the higher oil yield (and hence biodiesel yield) per kg of canola gives it an advantage over soybeans. In reality, the correct allocation lies somewhere in between the two extremes presented here, depending largely on the demand and value of the meal co-products from the canola and soybean oil processing prior to biodiesel production.

2.6 Summary and Conclusions

Based on the data and discussions presented above, the following key conclusions can be drawn regarding the agricultural production of canola and soybeans as precursors in biodiesel production:

1. One of the key uncertainties in the GHG impacts of canola based biodiesel is the emissions of N₂O. The IPCC emission estimates are ten times larger than field observations in western Canada. This underscores the importance of local soil and weather conditions, as well as agricultural practice in determination of GHG emissions from agricultural activities. The high price of fertilisers has led to far greater efficiency in their use and we believe that the field observations in Canada are more likely to represent actual GHG emissions than the IPCC guidelines. If so, the prevailing LCA emission rates are a factor of 10 too high. The difference between the IPCC estimates and field observations is roughly 1 kgCO₂eq/ litre of biodiesel.

2. Field observations have also shown the use of conservation tillage techniques to help with significant carbon retention in the soil. A number of studies point to long-term gains at the rate close to 20 gC/m²/yr establishing a new soil organic carbon equilibrium after 20 years. This translates into an additional 1 kgCO₂eq in carbon sequestration benefit per litre of biodiesel produced from HR canola grown using conservation tillage methods lasting for about 20 years.
3. More than 95% of canola grown in Canada Herbicide Resistant (HR). This has profoundly affected the way in which canola is grown. It has facilitated the low tillage practices, soil preservation, carbon sequestration, lower application rates for herbicides and hence a reduction in area runoff of agrochemicals.

For further reference, a comprehensive table summarizing the life cycle analysis data for Canadian canola and soybean production ² is provided in Appendix A.

3 From Grain to Oil

3.1 Introduction

This section will detail the energy and materials requirements and associated environmental impacts for the transportation and crushing of canola and soybeans into an oil feedstock.

3.2 Feedstock Transport

The first step in the extraction of canola or soybean oil from seed is the transportation of the raw grain from producers to a crushing facility. In Canada this transportation is typically by truck, with a limited amount of rail transport also in use. Very little data is available regarding the average distances that canola or soybeans are transported for crushing in Canada. Sheehan et al.⁵ provides data for the transport of soybeans to US crushers, and estimates an average distance of 120 km (75 miles) from farm to crusher. Based on this data, a Life Cycle Analysis for soybean transport was developed, and is presented in the following table.

Table 3-1 LCA of US Soybean Transport to Crusher⁵

Inputs / Outputs	Units	Per Ton of Soybean Transported to Crusher
Raw Materials		
Coal (in ground)	kg	0.106
Oil (in ground)	kg	3.400
Natural Gas (in ground)	kg	0.292
Limestone (CaCO ₃ , in ground)	kg	0.020
Water Use (total)	litre	0.473
Air Emissions		
Carbon Dioxide (CO ₂ , fossil)	kg	11.3
Methane (CH ₄)	g	4.06
Nitrous Oxide (N ₂ O)	g	1.13
Carbon Monoxide (CO)	g	38.4
Hydrocarbons (except methane)	g	8.27
Hydrocarbons (unspecified)	g	4.5
Particulates (PM ₁₀)	g	12.8
Particulates (unspecified)	g	2.42
Sulfur Oxides (SO _x as SO ₂)	g	16.69
Nitrogen Oxides (NO _x as NO ₂)	g	106.6
Water Emissions		
BOD ₅ (Biochemical Oxygen Demand)	g	2.28
COD (Chemical Oxygen Demand)	g	19.29
Solid Waste (hazardous)	g	7.42
Solid Waste (non-hazardous)	g	5.09
Total Primary Energy	MJ	162.2

Based on the distribution of Canadian crushing facilities, it is expected that average transport distances for Canadian canola and soybeans will be similar to that for US

soybeans. However, it should be noted that transportation from producer to crusher represents a very small portion of total energy consumption and emissions production in the overall production of biodiesel from canola or soybean oil. For example the figure of approximately 12 kg CO₂-eq GHG emissions for transportation to crushers is less than 2% of the 690 kg CO₂-eq emissions from N-fertilizer usage in crop production.

3.3 Crushing / Oil Production

Once the canola or soybean seed reaches the processing facility, a number of mechanical and chemical processes are used to separate the seed into two component parts: oil and meal. Figure 3-1 provides a simple block diagram of the canola crushing process, detailing the major products and their uses.

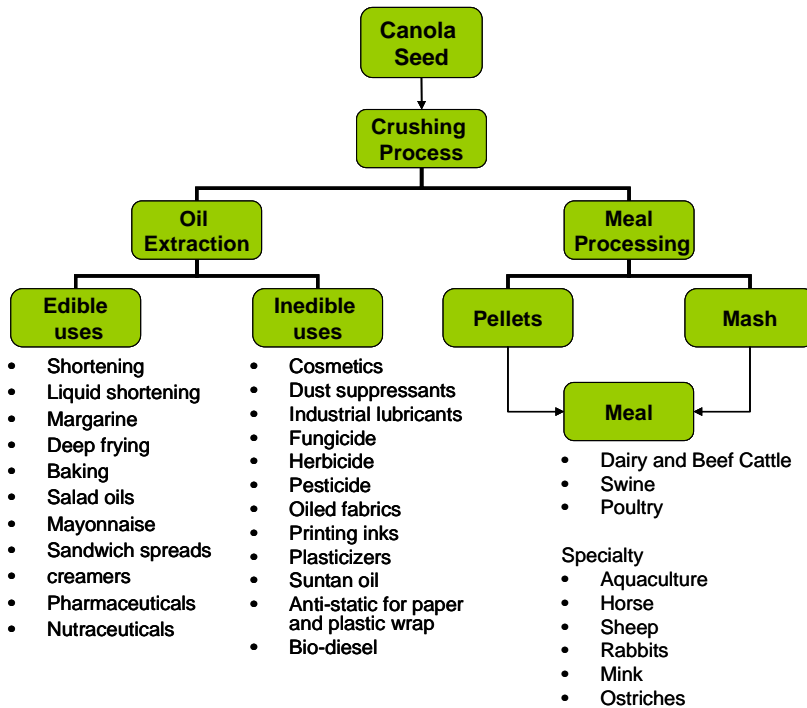

Figure 3-1 Canola crush processes ³

There are a number of variations on the process used to extract the oil from the canola seed used in Canada. A basic process is shown in figure 3-2.

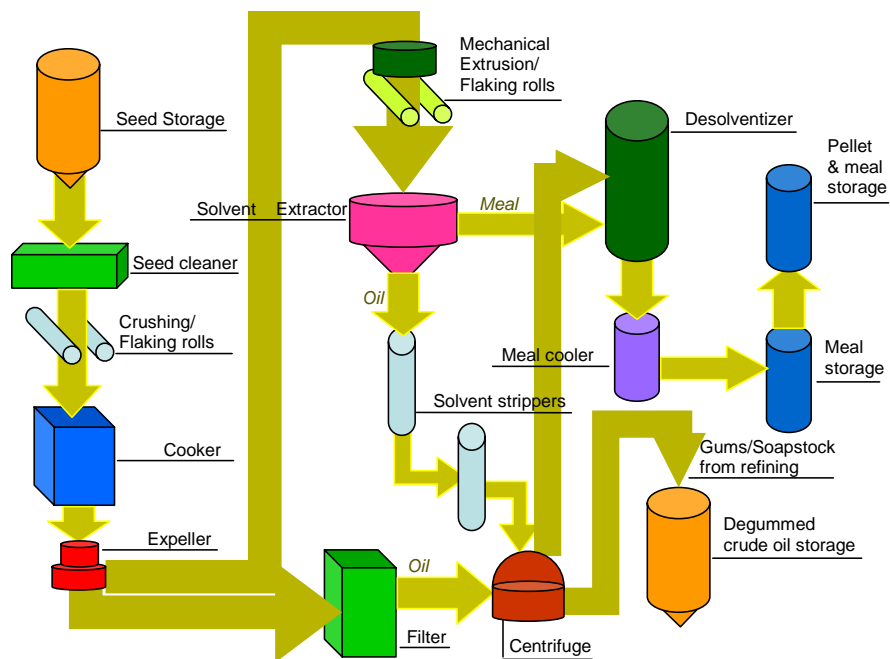

Figure 3-2 Canola crushing process adapted with modifications from ³

The production of edible vegetable oils including canola oil involves two overall processes, mechanical pressing and extraction, and further processing to remove impurities. The techniques used are similar for most vegetable oils produced from the seeds of plants. Soy oil processing is quite similar with some exceptions. Where applicable, the differences will be noted during the description. The following Step-by-step processing summary has been adapted from the CCC and CanolaInfo^{3, 34}.

3.3.1 Canola Seed Grading and Cleaning

The majority of canola seed is grown by Canadian farmers as a commodity crop, therefore the seed is commingled and not separated by variety or other specific traits. Following harvest, canola seed is delivered to the extraction plant from the farm and is graded and purchased according to a strict grading standard for canola established by the Canadian Grain Commission. The seed must meet the canola standard for erucic acid and glucosinolate levels which are the main factors differentiating canola and rapeseed oil. The graded seed is then cleaned by a number of different methods including air aspiration, indent cylinder cleaning, sieve screening, or a combination of these, to remove plant stalks, grain seeds and other materials from the bulk of the seed. Seed that has been cleaned is ready for subsequent export or for crushing into canola oil and meal.

3.3.2 Canola Seed Preconditioning

Seed which will be processed for oil and meal is preconditioned by being first heated to about 30-40° C to prevent shattering and moisture is then adjusted to improve subsequent oil extraction.

3.3.3 Canola Seed Processing

Following preconditioning, canola seed is next crushed and flaked on roller mills, set to very tight clearance, and then heated to about 75-100°C in cookers. These processes help to maximize oil recovery. The heat-conditioned seeds are then "prepressed" in screw presses or expellers to mechanically reduce the oil content from about 42% in the seed (on an 8% moisture basis) to between 16-20% so that solvent extraction of the remaining oil will be more efficient and economical. Screw pressing also compresses the flakes into more dense cakes (called "press cake") which may be put through a mechanical breaker to produce uniform sized particles and will be ready for solvent extraction.

Some discharge of very fine solids with the oil draining from the expeller is unavoidable. These fines are separated from the oil by gravity and filtration, and recycled to the conditioning stage.

3.3.4 Solvent Extraction of Canola

Press cake, which results from seed processing, is conveyed to the solvent extractor. Some cooling during conveying is done to minimize vaporization of hexane in the extractor. Hexane extraction reduces the oil content of the press cake to very low levels and results in oil essentially bland in taste, light yellow in color, and with excellent nutritional and stability properties. Oil recovery from canola seed is approximately 96%. This is accomplished by maximizing contact of the hexane with the press cake through a series of soakings or washings. In the extractor, the solids are first solvent-washed with hexane already high in oil content (miscella) and then with progressively leaner miscella and, finally with pure hexane. Residual hexane in the extracted press cake and oil is easily removed by evaporation at low temperature. Solvent residues in oils and meals, when produced in accordance with good manufacturing practice, can be said to be truly insignificant.

3.3.5 Stripping and desolventizing

The meal and the miscella are "stripped" of the solvent to recover solvent-free meal and oil. The solvent-saturated meal is conveyed to a desolventizer, which is a vertical tank equipped with heated trays and agitators. Reduced pressure and sometimes live steam are used to evaporate the hexane and to dry the meal. The hexane and moisture vapours are condensed, the water and hexane are separated, and the hexane is reused. Some removal of glucosinolates and their breakdown products and some protein denaturing occurs. To achieve the best meal quality, the process must be well controlled with respect to temperature (110°C max.) and time. The meal emerges free of solvent. It contains about 1% residual oil and 15 to 18% moisture. After drying to 8 to 10% moisture and cooling, the meal is often granulated to a uniform consistency and then is either pelleted or sent directly as a mash to storage.

The miscella containing the oil is desolventized in three-stage evaporator equipment. The hexane vapour from this operation is, also, condensed for reuse. A properly operated extraction plant loses no more than about 2-3 litres of hexane/mt of seed processed.

3.3.6 Degumming of Oil

The "crude" oil from the two extraction stages is usually blended and then degummed before being stored for sale or further processing. Degumming removes phosphatides coextracted with the oil, which tend to separate from the oil as a sludge during storage. The phosphatide content of crude oil varies, but is usually in the order of 1.25%, or measured as phosphorus, 500 ppm. Two degumming methods are in prevalent:

- o using water to precipitate phosphatides and;
- o using an acid such as citric, malic, or phosphoric and water (superdegumming).

After contacting the oil with these reagents, the oil is centrifuged to separate the precipitated material. Degumming with water only, leaves from 100-250 ppm of phosphorus, depending on the extent of hydrolysis of phosphatides in the course of seed preparation, as discussed earlier. In degumming with an acid and water, the hydrolyzed, non-hydratable phosphatides (NHP) are also removed. Residual concentrations are about 25 ppm of phosphorus. The separated phosphatides are added to the meal in the desolventizer. This raises the residual oil content of the meal to about 2-3% and raises its energy content^{3, 34}.

3.4 Canola and Soy

3.4.1 Canola Crushing Operations

In Canada, there are actually three different extraction processes used for canola.

- **Pure solvent extraction** similar to the soybean process commonly used in the USA
- **Expelling followed by solvent extraction** becoming more common in canola processing as the first phase readily removes 50-60% of the oil leading to lower fugitive emissions.
- **Physical extraction** only used in relatively small volumes by specialty crushers to yield higher-value functional oil products

The LCA analyses from Rollefson² show that when compared to diesel, hexane emissions are a significant source of VOCs as a precursor to summer smog,. However, it should be noted that the source of the precursors is very different. The VOCs from biodiesel are from the production and not from transport emissions, so are less likely to contribute to urban smog. Table 3-2 is adapted from ² to establish the Life Cycle Inventory of the canola crushing stage of the production of biodiesel from vegetable oil.

Table 3-2 LCI of canola crushing²

Input	
Canola seed	1000 kg
Steam (natural gas fired) (kg)	467 ^b
Electricity (kWh)	55 ^b
Make-up Hexane(kg) ^a	2
Natural gas (MJ)	1055
Output	
Canola Oil(kg)	410
Meal(kg)	590 (including 8.6 kg oil)

Hexane emission(kg)	2
---------------------	---

Notes:

- Large quantities of hexane are used but close to 98-99% is effectively recycled. LCI data associated with hexane manufacturing is taken from US NREL study⁵
- Data on actual energy consumption from Canadian oil crushers was not available, We reproduce data from Levelton and (S&T)⁷ for energy requirements for a rapeseed plant.

3.4.2 Soybean Crushing Operations

The generic crushing operation of the NREL study (section 5.3 of the Sheehan⁵ report) has been used by Rollefson ² with the difference of substituting the Canadian data into the NREL model. The Canadian 1999 average of 0.38kg/tonne (oilseed) hexane emissions per unit of grain processed was used. The mass allocation for a generic soybean crushing facility is 18% for the soybean oil and 82% for the soybean meal of the total 100%.

Table 3-3 Overall inputs and outputs for soybean crushing ²

		per tonne of soybeans processed ₁	per tonne of oil produced ^a
Inputs			
Energy	Electricity (kWh)	69.66	410.5
	Natural gas (MJ)	1115	6558
	Steam (MJ)	920	5419
Raw materials	Soybeans (kg)	1,000	5,891
	Hexane (kg)	0.38	2.24
	Water (kg)	3.28	19.4
Outputs			
Product	Crude, degummed soybean oil (kg)	169.73	1,000
	Soybean meal (kg)	760.1	4,478
Air emissions	Water vapour (kg)	69.28	408.2
	air (kg)	3.35	19.73
	Hexane (kg)	0.380 ^b	2,24 ^c
Water emissions	Total waste water (kg)	77.7	457.8
	Soybean oil (kg)	0.85	5.02
	Triglycerides (kg)	0.83	4.91
	Phosphatides (g)	0.2 g	0.0
	Unsaponifiable matter (g)	10 g	80
	Free fatty acids (g)	10 g	40
	Moisture (kg)	76.85	452.8
Solid waste	Trash metals (g)	8	46

Notes:

- a. This column would also give a close approximation to emissions for oil based on mass allocation. The mass allocation associates 18% of the inputs and emissions to the oil, and 82% to the meal. There are some small losses so the actual oil recovered is 16.973%. Therefore the mass allocation figures for oil would be the emissions of this column multiplied by 18/16.973, i.e. 6% higher.
- b. The 0.38kg (hexane)/tonne is based on an average Canadian crushing industry average.
- c. The original NREL Hexane emission data is 1,720 g (Hexane)/tonne (soybean), or 10,150 g (Hexane)/tonne of oil produced

3.4.3 Life Cycle Inventory of Canola and Soybean Crushing Operations

The following table from Rollefson² gives reasonably accurate data for the important parameters of crushing operations and allows reasonable estimates of GHG emissions to be made. The basis for the canola crushing inventory is good pertinent information but lacking in details and the soybean data is complete. The very large difference in wastewater produced is an artefact of these data sets and NOT of the two processes. Secondly, the hexane emissions cannot be considered comparable. While USA results show higher hexane emissions from canola than soybean, the large difference here has been artificially produced by using different data sets. The larger number from canola comes from the analysis of one specific plant while the soybean figure comes from an industry average over canola and soybean crushing operations. The difference is introduced only to show the range of values possible.

Table 3-4 LCI data for crushing of 1 tonne of canola and soybean with mass allocation^a.

²

Inputs (kg)	Canola	Soybean
Crude oil (resource)	0.5	0.3
Natural gas (resource)	24.3	54.6
Inert rock	1.0	2.2
Water	2.0	8.0
Outputs (g)		
Consumer waste	0.1	0.3
Hazardous waste	371	835
Ore processing residues	974	2192
Overburden	84.4	190
Carbon dioxide	62140	70050
Carbon monoxide	14.5	19.4
Hydrogen sulphide	9.4	21.2
Nitrogen oxides	161.5	187.6
Nitrous oxide	1.6	1.7
Steam	44130	47780
Sulphur dioxide	64.3	142.2
Benzene	0.2	0
Butane (n-butane)	0.6	0
Ethane	25.9	58.4

Formaldehyde (methanal)	0.5	0
Hexane	2000	409
NM VOC (unspecified)	8.7	19.6
Pentane (n-pentane)	0.9	0
Propane	10.7	23.7
Methane	119.4	265.6
VOC (unspecified)	2.5	0.5
Particles to air	0.7	1.4
Biological oxygen demand (BOD)	0.2	0.5
Chemical oxygen demand (COD)	1.4	3.2
Chloride	12.1	27.2
Fluoride	0	1.0
Sodium	10.3	23.2
Oil (unspecified)	0	916.4
Organic Compounds (unspecified)	0	918.2
Waste water	1644	87260
Steel scrap		8.4

Notes:

- a. Because the approximation has been made that all the seed is used, for each kg of seed 0.411kg ending up in the oil and 0.589kg in the meal, these numbers also represent the emissions for canola oil based on mass allocation.

3.5 Animal and waste fats

The rendering process recycles animal and poultry by-products, including bones, trim, fat, offal and feathers, and waste cooking oils into a broad range of commercial tallow (animal/vegetable fat) and protein products (meat and bone, poultry, feather, blood, fish and porcine meals). Tallow is used in the manufacture of products such as cosmetics, soaps, shampoos, candles, lubricants, paints, tires, perfumes, textiles, plastics, inks, polishes, cleaners, and solvents. Different grades of tallow are produced to meet the varying needs of customers worldwide. They are also an important source of fatty acids and glycerine for the chemical industry. The protein meals are usually sold directly to feed manufacturers as a high protein source for their feed formulas. The process steps involved in the rendering process are shown in the following figure⁷.

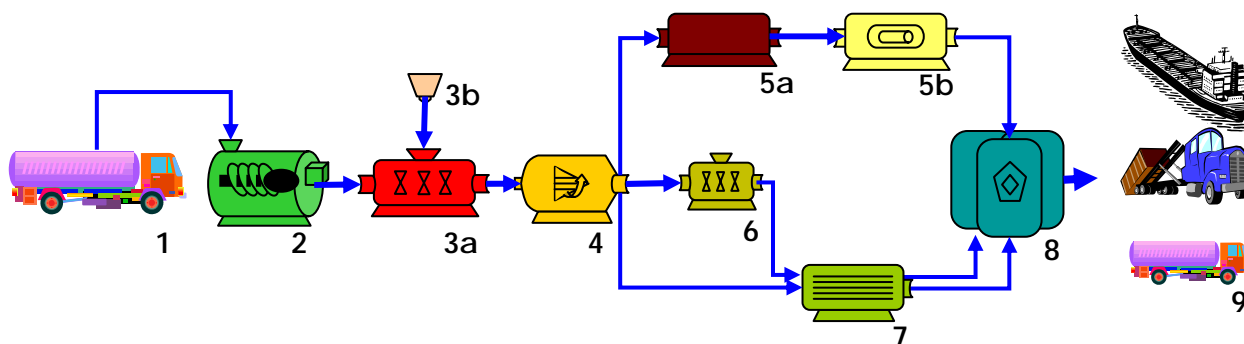

Figure 3-3 Rendering process ⁷

Notes:

The individual steps in the process are described below:

1. Trucks: collection from suppliers.
2. Grinder: each type of raw material is processed separately, starting with crushing.
- 3a. Cooker: releases natural proteins and oils of the animal by-products; feathers are hydrolyzed.
- 3b. Air purifier: for compliance with air quality standards.
4. Press: all materials are pressed to separate solids from liquids.
- 5a. Centrifuge: fats and oils are centrifuged to remove any remaining solids; blood is collected through coagulation and centrifuging.
- 5b. Polisher: fats and oils are further refined, filtered, and processed.
6. Dryer: fish solids and feathers are dried separately.
7. Mill: protein meals are milled separately.
8. Storage: all meals, fats, and oils are stored in tanks until shipped.
9. Transport: meals, fats, and oils are delivered via truck, rail, container, or ship⁷.

The rendering industry around the world has faced some significant challenges over the past several years in controlling disease transmission through their activities and products. This has resulted in some markets moving away from including tallow and animal meals in animal diets. The drop in demand has lowered the market value for these products.

Canada is the world's third largest exporter of tallow after the United States and Australia. In 2001, approximately 240,000 tonnes were exported (NRA). Tallow is produced in a number of grades; one of the differentiating factors is the free fatty acid (FFA) content. The lower grades generally have higher FFA contents.

The Canadian industry is dominated by Rothsay in eastern Canada and West Coast Reduction in western Canada. Rothsay, a division of Maple Leaf Foods, has six rendering facilities in Newfoundland, Nova Scotia, Quebec, Ontario (2) and Manitoba and another in Quebec that produces edible products. West Coast Reduction has plants in Saskatoon, Lethbridge, Calgary, Edmonton, and Vancouver. The Canadian industry had sales of \$3.2 billion (Statistics Canada cited in ⁷). The mass and energy balance for a typical rendering operation is shown schematically in figure 3-4.

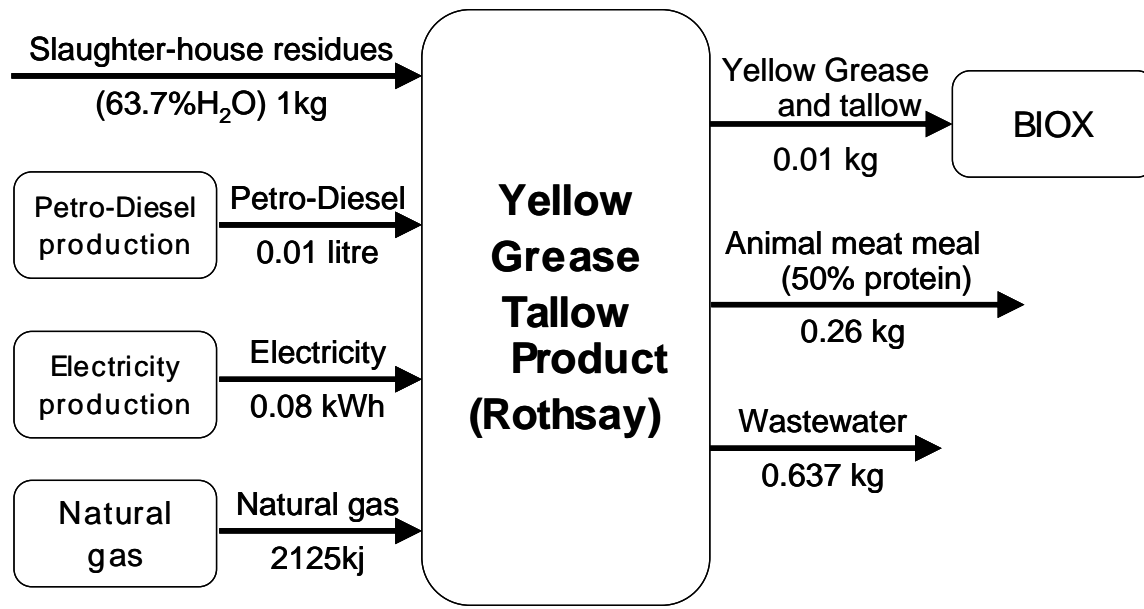

Figure 3-4 Mass and energy balance for rendering ²

This feedstock has a relatively high water content requiring heat for dehydration. The energy requirements to produce the oil for one US gallon of biodiesel are summarized in the following table⁷.

Table 3-5 Energy requirements for a tonne of bio-diesel from rendering tallow⁷

Electricity (kWh)	396
Natural Gas (MJ)	7790
Diesel Fuel (Litres)	53.4

The operation also produces protein meals as co-products. This material typically has a protein content of 50%.

Table 3-6 LCI inputs and outputs for production of 1 tonne of tallow - with mass allocation²

Inputs (kg)	
Crude oil (resource)	23.7
Natural gas (resource)	139.5
Inert rock	5.6
Water	11.4
Slaughterhouse residues	2778
Outputs (g)	
Consumer waste	0.7
Sludge	131.6
Ash	1.5
Ore processing residues	5597
Overburden	484.9
Carbon dioxide	36070
Carbon monoxide	180
Hydrogen sulphide	54.2
Nitrogen oxides	253
Nitrous oxide (laughing gas)	1.4
Sulphur dioxide	403
Ethane	150
NMVOG (unspecified)	50
Propane	59.7
Methane	924
VOC (unspecified)	27.2
Particles to air	12.2
Biological oxygen demand (BOD)	1.2
Chemical oxygen demand (COD)	8.2
Total organic bounded carbon	3.1
Chloride	69.5
Fluoride	2.7
Phosphate	0.1
Potassium	0.8
Sodium	59.2
Sulphate	0.4

Notes:

- One tonne of slaughterhouse residue produces on average 100kg of tallow and 260 kg of meal. Therefore the mass allocation associates $0.1/0.26 = 38.5\%$ of the emissions to the tallow and 61.5% to the meal.

4 From vegetable oil to diesel

4.1 Inputs and Outputs

Table 4-1 lists the inflows and outflows associated with the Biodiesel conversion process that defines the system boundaries of the analysis. In comparison, Table 4-2 and 4-3 list the mass and energy balance for refining crude oil to produce petroleum diesel fuel. Needless to say, petroleum refining constitutes a complex inventory of inputs and outputs. The overall energy loss is reported to be 5.2 MJ per litre of diesel fuel.

Table 4-1 Environmental inputs and outputs for biodiesel conversion ⁵

	<i>Environmental Flow</i>	<i>Units</i>	<i>Value</i>
IN:	Soybean Oil (degummed)	kg	1.04
	Sodium Hydroxide (NaOH, 100%)	kg	0.0023
	Methanol (CH ₃ OH)	kg	0.096
	Electricity	MJ elec	0.23
	Steam	kg	1.03
	Water Used (total)	L	0.36
	Sodium Methoxide (CH ₃ ONa)	kg	0.024
	OUT:	Biodiesel (neat, kg)	kg
Crude Glycerine		kg	0.15
Soapstock		kg	0.00054
Water (chemically polluted)		L	0.38
Waste (total)		kg	0.012

Table 4-2 Mass and energy balance calculations for an average US refinery

M.S. Graboski								
1994 EIA Based U.S. Refinery Mass and Energy Balance Spreadsheet Model								
Sep-97								
Energy Contents of Fuels on a HHV Basis. Adjusted to LHV								
	Refinery Production					Refinery Inputs		
	spg	MJ/liter	Liters	kg	MJ	Liters	kg	MJ
Crude	0.87	39	0	0	0	8.0 E+11	7.0 E+11	3.2 E+13
Imported Energy								1.4 E+12
Natural gas liquids	0.55	25	3.5 E+10	2.0 E+10	8.9 E+11	2.7 E+10	1.5 E+10	6.8 E+11
Other Liquids	0.72	28	0	0	0	4.0 E+10	2.9 E+10	1.1 E+12
Gasoline	0.72	34	4.2 E+11	3.0 E+11	1.4 E+13	0	0	0
Jet + Kerosene	0.81	37	8.7 E+10	7.1 E+10	3.3 E+12	0	0	0
Low sulfur distillate	0.86	39	1.1 E+11	9.1 E+10	4.1 E+12	0	0	0
High sulfur distillate	0.86	39	8.0 E+10	6.9 E+10	3.1 E+12	0	0	0
Residual fuel oil	0.88	40	4.8 E+10	4.2 E+10	1.9 E+12	0	0	0
Coke		40	3.6 E+10	4.1 E+10	1.4 E+12	0	0	0
Special Oils & Lubes	0.90	40	3.7 E+10	3.3 E+10	1.5 E+12		0	0
Waxes, Asphalt, Road Oils	1.0	43	3.0 E+10	3.0 E+10	1.3 E+12		0	0
Miscellaneous	0.90	40	2.8 E+09	2.5 E+09	1.1 E+11		0	0
			8.8 E+11	7.0 E+11	3.2 E+13	8.7 E+11		
Still gas	0.73	40	3.8 E+10	2.8 E+10	1.5 E+12			
Catalyst Carbon		40	1.3 E+10	1.5 E+10	5.1 E+11			
Heat loss, cooling water					8.4 E+11			
Grand Total Inputs & Outputs			9.2 E+11	7.4 E+11	3.5 E+13		7.4 E+11	3.5 E+13
% Thermal inputs, output basis					10.6%			
% Losses, output basis					5.72%			13.2%
Energy loss MJ/liter product								5.2
Net product (less pass through)				7.0 E+11				

Table 4-3 Energy Inputs for diesel production in an average US refinery ⁵

Process Energy Inputs	
	Liters
LPG	1.6 E+09
Distillate	7.9 E+07
Resid	1.5 E+09
Still Gas	3.7 E+10
Coke	4.4 E+08
Catalyst Carbon	1.3 E+10
Natural Gas	1.9 E+10
Coal	8.2 E+07
Electricity	1.1 E+10
Steam	9.5 E+08
Hydrogen	0
Other	2.2 E+08
Energy Imports	3.5 E+10
Total Energy	8.5 E+10
Energy Imports MJ	1.4 E+12
Total Energy MJ	3.4 E+12
Total Cooling Water liter/bbl crude	4738.82
MJ/Bbl crude @15F rise	165

4.2 Transesterification Reaction

Biodiesel (alkyl ester) is usually produced by the transesterification of a lipid feedstock. While biodiesel can also be produced using a gasification route, most reports pertaining to lifecycle study on Biodiesel process are for the transesterification process as it is the process of choice in commercial production⁵. Transesterification is the reversible reaction of a fat or oil (both of which are composed of triglycerides and free fatty acids) with an alcohol to form fatty acid alkyl esters and glycerol.

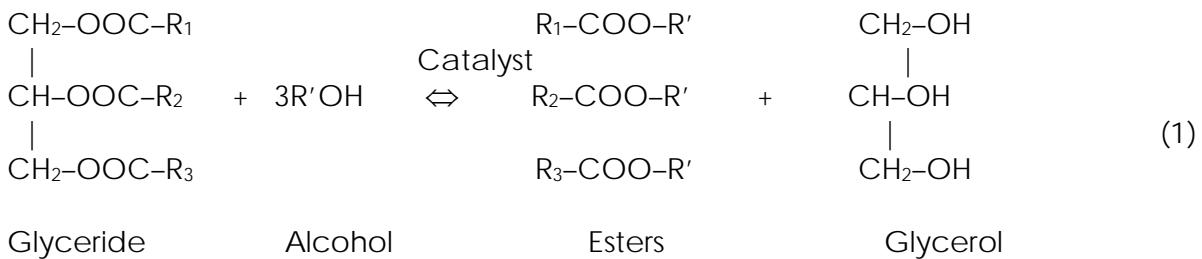
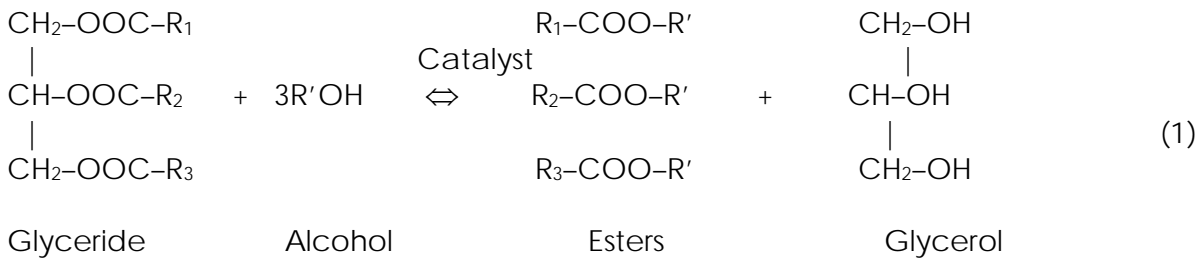

Transesterification can be alkali-, acid- or enzyme-catalyzed; however, enzyme catalysts are rarely used, as they are less effective³⁵. The reaction can also take place without the use of a catalyst under conditions in which the alcohol is in a supercritical state^{36, 37}. However, currently commercialized technology resides in transesterification using alkali catalyzed reaction.

System boundaries from oil to Biodiesel process is summarized by Figure 4.1 based on the material balance of the process broken down to 6 sections⁵.

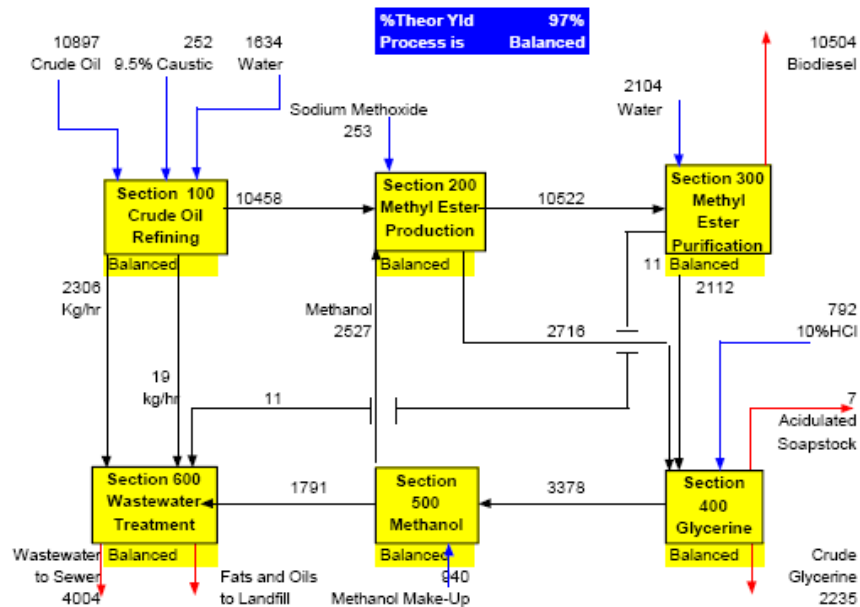

Figure 4-1 Overview of the transesterification process for conversion of soybean oil to biodiesel (flows in kg/h)⁵

4.3 Feedstock

Various feedstocks may be used to produce biodiesel. The base case reported here is for soybean oil conversion as with most biodiesel production in the U.S. However, as noted throughout this report, the difference incurred from the feedstock can be significant. The (S&T)² Consulting report lists the comparison of lifecycle GHG emission, energy intensity of fuel production, separate GHG gasses and non-GHG emissions by stages between petroleum diesel and biodiesel produced from canola, soy bean, tallow, yellow grease and fish oil. The differentiation between low and high free fatty acid content of the feedstock is due to its inhibitory reaction with free fatty acids in an alkali catalyzed transesterification reaction.

Glycerine co-product credit is shown to significantly offset the energy and emissions from the transesterification process. Furthermore, conversion to biodiesel results in greater GHG reductions compared to combusting raw feedstock in an engine.⁴

4.4 Catalyst

Alkali catalysts used in transesterification include sodium hydroxide, potassium hydroxide, and sodium methoxide. To the best of the authors' knowledge, no lifecycle assessment comparing the impacts of different catalysts used for transesterification has been reported. Use of potassium hydroxide, a by-product of chlorine production in chloroalkali process, can alter the process evaluation.

4.5 Ethanol for transesterification

The motivation for the use of ethanol in place of methanol for transesterification originates from the potential to become independent of petroleum-based alcohol as ethanol can be produced from agricultural renewable resources. However, not only is the reaction rate with ethanol slower than that with methanol, but also ethyl ester has close to 30% higher breakeven cost compared to methyl ester using rapeseed oil as feedstock³⁸. Further comparison between ethanol and methanol on engine performance and emissions testing are reported in Peterson et al.³⁹ and Peterson and Reece⁴⁰, respectively.

4.6 Process

Various processes are available commercially to produce biodiesel. As listed in Table 4-4, requirements of power, fuel and catalyst (sodium hydroxide) differs significantly. Comparison between Lurgi and BIOX technologies based on energy and material requirements has been reported by Rollefson et al.². BIOX is a Canadian process developed by Prof. Boocock of the University of Toronto, using a co-solvent to efficiently convert high free fatty acid content in the feedstock. Owing to its versatility, "the BIOX process appears to be a conservative choice in determining the full requirements for a biodiesel production plant."²

Table 4-4 Transesterification input requirements per tonne of biodiesel⁴⁾

	Power (kWh/tonne)	Fuel (MJ/tonne)	Methanol (kg/tonne)	Sodium hydroxide (kg/tonne)
Lurgi	12	1207	96	1.5
Elsayed	23	1724	109	12
Gemis	45.8	1375	109	6
Crown Iron	17	1000	78	20
NREL	29	1687	90	25
LBST	13	1260	92	6
BioFit -Austria ^a	260	3160	100	15
BioFit Germa ^a	73	4260	107	6

Notes:

a: Includes the rapeseed crushing stage

5 Spills

While regrettable, oil spills do happen. Fossil oil spills have caused major impacts on the terrestrial, fresh water and marine environments. Highly volatile gasses and toxic emissions have impacted human and animal health, while we are all familiar with tragic pictures of sea birds covered in crude oil and dead fish floating on lakes and rivers. Biodiesel is highly biodegradable with a half life of a few days as opposed to months and years and is expected to have far less harmful impacts if spilt in the environment. Because of its solvent characteristics and ability to mobilise fossil oils and distillate products, biodiesel is being considered as a possible remediation measure where oil spills need to be mopped up through mobilization.

International Tanker Owners Pollution Federation (ITOPF) collects data on global oil spills from tankers, combined carriers, and barges. The total figure for the 1970-2005 period amounted to 5,625,000 tonnes of which 167,000 tonnes was spilled in the period between 2000 -2005. These figures do not include spills resulting from war⁴¹. According to the pollution data collected and reported by the US coast guard the total volume of spills in the US water bodies during the years between 1973 and 2001 was 740,000 tonnes ⁴².

In Canada between 1984 and 1995, 37,000 spills (39% of the total) occurred from crude oil, gasoline, and other fuel sources. This number of spills discharged 320,000 tonnes of oil and oil products to the environment, an average of approximately 26,700 tonnes/year. The Percentage distribution of environment affected by the oil spill category ranges from around 30%- 40% for air and freshwater to 60-80% for land, saltwater, groundwater, and other environments ⁴³.

The environmental impact of a biodiesel spill can be assessed through its toxicity and decomposition mechanisms in marine and terrestrial environments. Owing to its nature of the "environmentally friendly" fuel, biodiesel has been used in "National Parks, sensitive waterways, and other locations where environmental or human health concerns are especially important (underground mines)"⁴⁴ Complete degradation of biodiesel was observed in 7 and 14 days under aerobic and anaerobic conditions, respectively.⁴⁵ A study on the toxicity comparison between diesel fuel and biodiesel in aerated soil⁴⁶ has revealed that diesel fuel displays toxic properties at concentrations above 3 wt. %, while biodiesel indicates no toxicity up to a concentration of 12 wt. % based on biotransformation of CO₂, humus compounds, non-biodegradable material, and intermediate biodegradation products. Clearly, the concentrations of oil released in the environment will affect the impact. Extensive study in aquatic systems has been reported on biodegradation of neat vegetable oil, biodiesel, and petroleum oil using CO₂ evolution and GC methods⁴⁷. Biodiesel consisting pure fatty acids of hydrocarbon chains in ester form with two oxygen atoms, naturally existing enzymes can readily attack and degrade the molecules. The mineralization rate determined by CO₂ evolution reflecting the biodegradation rate is reported to be 25 mg/L/day and 12.5 mg/L/day for biodiesel and petroleum diesel, respectively. Furthermore, the biodegradation of a mixture of biodiesel and diesel is faster with increased portion of biodiesel in the mixture.

In a more recent application, Fernandez-Alvarez et al. ⁴⁸ reports on the use of biodiesel as biosolvent to promote bioavailability and biodegradation rates for petroleum oil components with low aqueous solubilities in an oil spill. Their study suggests a possible induction of increased microbial activity with biodiesel addition acting as a source of bioavailable carbon as well as by dissolving the layer of weathered oil and exposing the hydrocarbon-degrading bacteria to fresh oil. Preliminary study on the use of biodiesel to remove spilled vegetable oil using biodiesel has shown the advantage on the use of biodiesel which has no long-term toxicity or damage to the environment⁴⁹.

The impact of mineral oil spills on surface water during the production of biodiesel and petroleum diesel fuel has been reported as 0.94 – 1.18 g and 0.06 – 0.08 g per kg diesel fuel equivalent⁵⁰. This confirms on the lower environmental impact of accidental spills involved in the production of biodiesel relative to petroleum diesel.

6 From Combustion to environmental impacts

6.1 Introduction

Use of diesel fuel in boilers and internal combustion engines results in the release of unwanted pollutants. Of interest are the impacts associated with biodiesel use compared with conventional fossil-diesel use. Impacts can be considered in terms of emissions, ambient concentrations, human health and other environment effects. These impacts express themselves at different spatial scales ranging from: the local scale (within a few kilometres of combustion source) where impacts are mainly associated with the direct emissions; to the regional scale (within hundreds of kilometres of combustion sources) where impacts are associated with both the direct emissions and the formation of secondary pollutants; and at the larger continental and global scales (distances greater than 1000 kilometres) where impacts arise from greenhouse gases and acid rain. This review summarizes both measured and predicted impacts associated with the use of biodiesel as presented in scientific literature.

6.2 Emissions

Emissions are usually classified by the type of pollutant being emitted and by the nature of the source emitting them. Typically, emissions are classified as being regulated (CO, NO_x, HC and PM), toxic (comprising a large set of chemical compounds which are known or suspected to cause cancer or other serious health effects⁵¹) or greenhouse gases (compounds which readily absorb thermal infrared radiation and contribute to anthropogenically induced climate change). Anthropogenic emissions sources are disaggregated into mobile (heavy-duty diesel vehicles, light-duty diesel vehicles, non-road vehicles, and marine vessels) and stationary (boilers, furnaces and generators) sources.

Regardless of type of pollutant or source, emissions rates are difficult to determine and are seldom measured in the field. Instead, emissions rates are typically measured in controlled laboratory environments. In-use emissions are then estimated using the laboratory measured rates along with empirical factors designed to account for equipment deterioration and in-use operating conditions^{52, 53}. There is much uncertainty about the representativeness of laboratory measured emissions, especially for mobile sources⁵⁴, and about the accuracy of the empirical factors used to adjust laboratory based results to real-world conditions⁵⁵. As a result, emission estimates have large uncertainties that must be kept in mind when examining the effects of biodiesel use on emissions. To further complicate matters, biodiesel emission rates are generally sensitive to the blend of biodiesel, the base diesel fuel used in the blending and the source of the biodiesel feedstock (e.g. plant based or animal based).

6.2.1 Mobile Sources

Mobile source emissions are a major source of pollutants in most urban areas with diesel fuelled vehicles significant contributors to NO_x, SO₂ and PM emissions⁵⁴. Heavy-duty vehicles (HDV) are the most important class of diesel powered mobile sources and, while only representing a small fraction of the total mobile fleet, contribute a significant

fraction to the total distance driven, fuel consumed, and emission released. The two main classes of HDV are truck and buses. Unlike light-duty vehicles, HDV emission standards are based on engine and not vehicle testing with bus engines subject to more stringent standards.

The vast majority of diesel fuel is consumed by long-haul transport outside urban areas. Figure 6-1 depicts a breakdown of available data on diesel fuel sales in Canada between 1988 and 2004 (Transport Canada). The trend line for private automobiles has been estimated using a rising share of diesels as a fraction of all private automobiles. Sale of diesel to commercial vehicles is an aggregation of pump sales minus the sales estimated for private automobiles plus bulk sales to commercial fleet operators. These figures show that of the 17.5 billion litres of diesel sold in Canada in 2004, 69% fuelled heavy-duty trucks & buses and only 6% went to fuel light duty vehicles. When considering the diffusion of biodiesel in Canada, the primary target is the large commercial fleets, urban transit, and long-haul trucking.

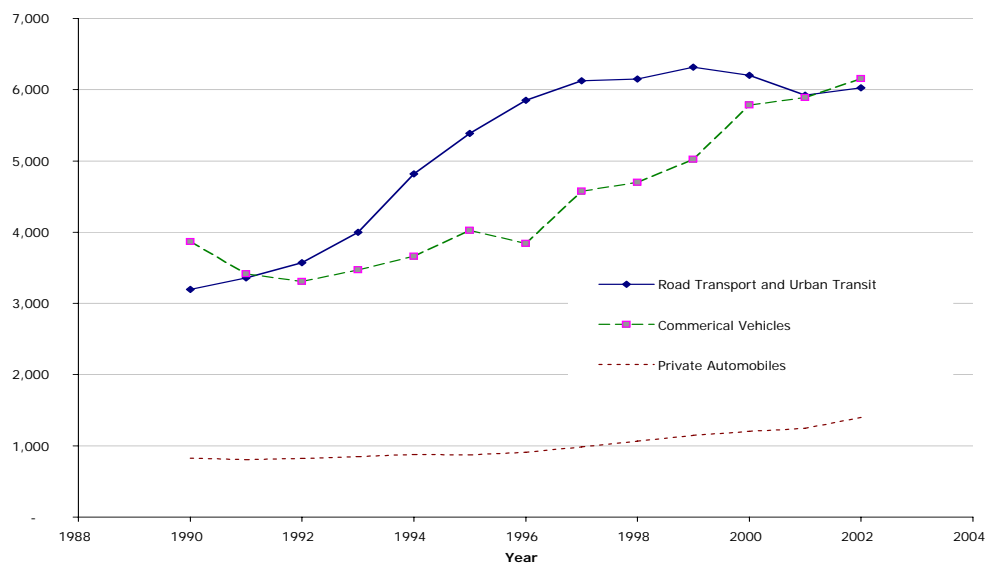

Figure 6-1 Commercial vehicles, longhaul trucks and urban transit account for more than 12 million litres of sales while private automobiles consumer about 10% of that volume in diesel fuel per year.

Heavy Duty Diesel Vehicles

The US EPA ⁵⁶ has undertaken an extensive review of biodiesel emissions from HDV. They analyzed results from a number of laboratories' emission tests in order to develop a statistical relationship between biodiesel fuel use and regulated and unregulated emissions rates. All conclusions are based on engine dynamometer tests running the EPA heavy-duty transient Federal Test Procedure (FTP) test cycle or the European 13-mode steady state HD test cycle using pre-1997 engine technologies.

Their meta-analysis shows that on average, biodiesel fuels reduce PM, HC and CO emissions while slightly increasing NO_x emissions. The amount of change is dependent on the percentage of biodiesel in the fuel with reductions (PM, HC and CO) and

enhancements (NO_x) increasing as biodiesel fraction increases. Their results also show a decrease in fuel economy, with a 1-2% drop for a 20% biodiesel blend (B20).

The studies find a noticeable difference in emissions from animal-based and plant based biodiesel with soy and rapeseed producing higher NO_x increases and smaller PM and CO decreases. The report also finds the use of biodiesel fuel reduces the total amount of toxics emitted but for some specific toxics an increase can occur.

There are a number of limitations of this study. For example, the analysis did not consider emissions tests from engines equipped with exhaust gas recirculation (EGR) or other emission control devices designed to meet the 2004 heavy-duty engine certification standards. Vehicles equipped with such emission control devices may form a large part of the HD fleet in the future. Additionally, the analyzed tests did not include newer model year engines which may have different emissions characteristics; all of the results are based on engine dynamometer testing which may not correlate well with actual in-use emissions (the EPA is developing a new set of in-use testing procedures to better estimate actual emissions rates (Environmental Protection Agency, 2005)); and most tests involved soy-based biodiesel which may not give results representative of other biodiesel fuels. Recent investigations have been undertaken to supplement the EPA study.

Environment Canada⁵⁷ tested two newer model year Cummins 250-HP diesel engines (a 1998 mechanical fuel injection and a 2000 electronic fuel injection) using biodiesel from 3 different sources (vegetable oil, animal fat and used cooking oil) and a degreened diesel oxidation catalyst in place. Results from tests at two different biodiesel blends (B5 and B20) found that NO_x emissions were not significantly affected by the biodiesel use. Furthermore, with the electronic fuel injected engine, they found statistically significant NO_x reductions with all biodiesels except the vegetable B20 blend. Their results also showed significant decreases for CO and PM emissions and reductions in HC emissions (with the exception of the B5 cooking oil blend in the mechanical engine). They did not find a change in fuel consumption or a significant power loss. Environment Canada found increase in organic portion of PM and increase in soluble organic fraction. Sulphates were reduced as well. However, in another investigation using late model year engines certified to meet 2004 emission standards and with EGR systems⁵⁸, NO_x emissions were found to increase for all biodiesel fuels and engines tested. PM decreases were observed which were greater than those found for older engines.

Lipman and Delucchi⁵⁹ survey various biodiesel tests aimed at limiting increased NO_x emissions stemming from biodiesel use. Their report shows the use of oxidation catalyst reduces CO and HC emissions but produces higher HC at some engine operating characteristics. The CO reductions were dependent on engine load but not engine speed with the greatest reductions found at full load. The oxidation catalyst lead to increased PM concentrations, particularly at higher engine loads, but little change in NO_x emissions. In general the oxidation catalyst provided reductions in CO and HC but at the expense of PM emissions. The report examined engine testing using EGR systems showing NO_x emissions can typically be reduced without increasing PM, other emissions or fuel consumption but noted that in order to achieve these results, the EGR ratios had to be optimized with load. The report also examined tests where injection timing has

been altered. Retarding the injection timing can reduce NO_x emissions without increasing PM emissions but often at expense of increased fuel consumption. With a B50 biodiesel blend significant power loss was observed when the timing was retarded. It was found that timing changes could not reduce both PM and NO_x emissions simultaneously.

Environment Canada⁶⁰ analyzed the effects of using a selective catalytic reduction (SCR) technology and particulate trap onto an in-use diesel engine. Engine dynamometer testing using the US EPA Heavy Duty FTP transient cycle, with both a low sulphur diesel and a blend of 20% canola methyl ester showed no noticeable difference in engine speed, torque and power changes between the SCRT and OEM when using the B20 blend. The use of biodiesel did not significantly alter the effectiveness of the SCR technology which produced decreases in CO, THC, and TPM greater than 95% and NO_x decreases up to 70% compared with OEM using ULSD. The SCR technology increased NO₂ emissions for both the ULSD and B20.

In an attempt to quantify actual vehicle, and not just engine emissions, Wang et al.⁶¹ performed chassis testing of 9 trucks having two different engine types. Vehicle emissions using a B35 soy based methyl ester blend were compared with emissions using conventional diesel. The vehicles were tested over the West Virginia University (WVU) truck driving cycle and the WVU 5-mi driving cycle simulating a series of five accelerations to different peak speeds. While the results showed large variability, they found decreases in PM, HC and CO with the B35 blend. While NO_x emissions were found to be roughly the same, they noted the following: with the late 1980s Cummins engines, NO_x emissions increased while with the later model year Detroit Diesel engines, NO_x emissions decreased.

Instead of using a chassis dynamometer to test HDV emissions, Environment Canada ⁶² performed in-use testing of city buses in the Halifax Metropolitan area. Two buses were run over an 8.5 km route while THC, CO, NO_x, and TPM emissions and vehicle operating characteristics (exhaust temperature, engine speed, vehicle speed, and engine air intake) were monitored. The buses ran on a B20 blend of biodiesel and showed: statistically significant decrease in CO (18%-28%); mixed results for TPM and THC; and no statistically significant increases in any of the measured emissions.

Light-duty diesel vehicles

While diesel fuelled light-duty vehicles (LDVs) have had limited market share in North America, as their engine technologies improve their higher efficiency will make them ever more attractive with rising fuel prices. Their market share will not increase until they are able to meet Tier II pollution controls. At present, only one manufacturer (Mercedes Benz) is marketing vehicles able to meet the standards being enforced in North America starting January 2007. Other popular diesel manufacturers in Canada (VW) will not be marketing their diesel products for the 2007 model year until they can find an economical approach to meeting the new and exacting PM and NO_x standards.

Durbin and Norbeck⁶³ have studied the effects of biodiesel blends and a special emissions control diesel on light duty vehicles using a chassis dynamometer. Tests used

two types of biodiesel (soy-based and yellow grease) and 7 different light duty vehicles. In general, the soy based biodiesel produced smaller emissions reductions than the yellow-grease biodiesel (compared with the baseline test diesel fuel) with a small increase in PM. There was little difference with NO_x emissions with all of the test fuels.

Non-road vehicles

Non-road vehicles include construction and agricultural equipment, locomotives and marine engines. These vehicles have been less regulated and are becoming a more important source of mobile emissions as HDV and LDV emission standards become more stringent. Compared with on-road engines, there is less dynamometer or in-use emissions data from non-road engines with only a very limited number of biodiesel tests. The Southwest Research Institute (SWRI) has emissions testing of a line-haul 2000 hp EMD GP38-2 locomotive line-haul and switch duty cycle using regular diesel fuel, a B20 blend and a 20% blend of biodiesel into CARB diesel fuel (C20)⁶⁴. Tests were performed using both the EPA line-haul and switch duty cycle and showed a 4% to 6% increase in NO_x emissions with B20 and little change in PM concentrations. The lack of significant PM reductions is thought to stem from the fact that for the two-stroke EMD engine, most of the measured PM emissions are lubricating-oil derived and not from the fuel oil combustion. CO emissions were also reduced for the B20 and C20 blends but the changes were not statistically significant due the relatively large between test variability.

In-use emissions testing of a fleet of 12 tour boats operating in the province of Quebec during the summer 2004 tourist season was performed by Environment Canada⁶⁵. The tests used various biodiesel blends ranging from B5 to B100. Emissions testing showed significant decreases in PM, CO, THC, SO₂, PAH and PM_{2.5} with a slight increase in NO_x emissions.

A slight (1%) decrease in CO₂ emissions was also observed. One of the marine engines was used for controlled laboratory engine dynamometer testing and showed no power loss and only a slight increase in volumetric fuel consumption. The use of biodiesel caused some minor issues with fuel filter clogging due to the increased solvent nature of biodiesel and this required more frequent filter changes.

6.2.2 Stationary Sources

Biodiesel can be used in boilers and furnaces with few or no modifications to equipment or operating practices. Emissions testing of biodiesel in residential size boilers for space heating purposes by Krishna⁶⁶ shows reduced smoke and NO_x emissions for a soy-based biodiesels (B10, B20, B30) blended with No. 2 diesel and a blend of 50% biodiesel with kerosene. The tests showed increasing reductions at higher biodiesel levels. A similar study in Massachusetts⁶⁷ compared emissions from a range of boilers and furnaces using conventional home heating oil with a B20 soy-based biodiesel blended with 80% low-sulphur highway diesel. The tests show biodiesel NO_x reductions around 20%, lower CO levels, reductions of sulphur oxide emissions of up to 83% and lower smoke numbers. It is thought that the lower flame temperatures in the boiler contribute to the observed biodiesel NO_x decreases which are in contrast to the observed NO_x increases for internal combustion engines. More study is needed to fully characterize NO_x formation in this combustion environment.

6.3 Impacts

Quantifying biodiesel impacts on air quality and human health is more difficult and uncertain than estimating changes in emissions. In addition to calculating the expected emission changes stemming from biodiesel use, the estimation of ambient pollutant concentration must take into account the advection and dispersion of emissions by the mean winds and turbulent processes along with any possible chemical transformations. Such estimates are usually quantified using chemical transport models coupled with high-resolution meteorological models⁶⁸. Probably the most difficult ambient concentrations to quantify is the formation of secondary pollutants like ozone and PM_{2.5} where formation rates are sensitive to the mixture of pollutants already present in a given air shed. Calculated ambient concentrations of these two pollutants are often used to help quantify expected health impacts due to acute exposure.

6.3.1 Ambient Concentrations

One of the concerns with the use of biodiesel is the measured increase in HDV NO_x emissions. It is well known that ozone and secondary particulate formation are sensitive to concentrations and relative abundance of NO_x and VOC⁶⁹. In many cases, ozone obeys a law of the minimum in which ozone formation is limited by the precursor (NO_x or VOC) in shortest supply⁷⁰. Furthermore, many suburban and rural areas downwind of major US cities are thought to have ozone concentrations limited by NO_x⁷¹. Thus, any increase in NO_x emissions stemming from biodiesel use could potentially lead to increased ozone concentrations, despite expected reductions in ambient concentrations of other species (e.g. CO and PM). To date, few analysis have been carried out on the effects of biodiesel use on ambient concentrations although the National Renewable Energy Laboratory in the US has undertaken a set of modeling studies examining the effects of HDV biodiesel use on: CO in Las Vegas NV.; ozone in the Northeast Corridor of the USA; ozone in the Lake Michigan region; and ozone and PM in the South Coast (Los Angeles) Air Basin (SoCAB) regions⁷²⁻⁷⁴. The analyses use numerical models to predict ambient concentrations under three different emission scenarios: a standard diesel base case; a high adoption case which assumes a 100% penetration of B20 in the HDV fleet; and a moderate adoption case assuming only 50% penetration of B20 in the HDV fleet. For each scenario and for each modeling region, emissions inventories were first developed by updating available databases with addition of HDV emission factors designed to reflect emission changes stemming from biodiesel use. These factors were developed through an analysis of measured laboratory engine tests. The various inventories showed little differences – total NO_x, VOC and CO emissions varied by less than 1% – for all of the modeling regions and all of the modeled species. The differences between predicted concentrations for the base case and two biodiesel scenarios are very small (< ±1%) and generally confined to regions in and around the urban areas. These results are not surprising, given the limited differences in emissions although probably not conclusive given the large uncertainties in the base emissions inventories⁷⁵. A better approach to estimating the effects of biodiesel use might be through a statistical analysis of measured concentrations similar to the ones used to determine weekday/weekend air quality effects⁷⁶. Such analyses attempt to correlate observed differences in average weekday/weekend ozone measurements with the small differences in VOC and NO_x emissions that occur between weekdays and weekends.

No HDV biodiesel modeling has been done in Canadian urban regions. However, it is worthwhile examining the modeling performed by Hedley et al.⁷⁷ on the effects of substituting CNG and LPG into the Lower Fraser Valley (LFV) light duty vehicle (LDV) fleet. Their emissions inventory analysis showed CNG substitution would result in a substantial reduction in NMHC emissions and a moderate reduction in NO_x emissions while an LPG substitution would result in a large reduction in NO_x emissions with only moderate reduction in NMHC emissions. Photochemical modeling using these inventories showed the CNG substitution leads to decreases in ozone concentration in the suburban and rural areas up-valley from the Vancouver area while the LPG substitutions lead to ozone decreases in the rural areas but increases in the urban regions. While the estimated CNG and LPG emissions changes are greater than those expected for a HDV biodiesel substitution, the modeling results show fuel substitutions can have a noticeable effect on regional air quality.

6.3.2 Health Impacts

While the ozone precursor impacts have been the focus of many studies, the key benefit from bio-based diesel is reduction in toxic emissions. A 5% reduction in the risks associated with toxic emissions is estimated from modeling results in the SoCAB⁷⁸. However, while some suggest biodiesel use will increase NO_x in the air shed, they find no change in risk associated with ozone, NO_x and PM exposure. In other words, the change in toxic emissions from having a biodiesel blend leads to a measurable health benefit. On the other hand, the change in criteria pollutant emissions does not impact health outcomes either positively or negatively.

6.3.3 Acid Rain

The lower sulphur content in biodiesel fuel results in lower SO₂ and sulphate emissions⁵⁷ should result in reduced contributions to acid rain formation.

6.4 Conclusion

The use of biodiesel in internal combustion engines has been shown to reduce PM, CO, and HC. In addition, emissions of most toxics are reduced. It appears that NO_x emissions may show a slight increase but the actual change in NO_x emissions appears to depend on a number of factors including: the type of testing, engine being tested, type of biodiesel, biodiesel blend and type of base diesel fuel. Perhaps more significant than the small NO_x increase, is the fact that biodiesel has a low sulphur content. This will facilitate the use of sulphur sensitive emission control after treatment devices which can substantially reduce NO_x emissions. Limited modeling shows no impact of biodiesel use on ozone or PM formation in the SoCAB area and a small decrease in risk associated with air toxics. Biodiesel use in boilers and furnaces shows a decrease in NO_x and smoke emissions.

There are three areas where biodiesel differs from fossil diesel. Biodiesel has a much higher cetane number. A higher cetane number makes diesel engines easier to start and smoother running. Biodiesel also has a higher lubricity than fossil diesel unless the latter has high sulphur content. The lubricity in biodiesel makes it an ideal blend for low sulphur diesels now mandated for distribution in North America. Finally, biodiesels are

strong solvents and may dissolve tank sediments carrying them into the engine. As the quality of diesel rises and with prolonged use of biodiesel blends this should only be a short-term challenge of long-standing diesel users switching to biodiesel blends. Existing long-term test data do not show any harm to engine performance or longevity with a wide range of biodiesel blends.

7 Fossil-diesel Life cycle

7.1 Introduction

This section will detail the energy and materials requirements and associated environmental impacts for production of fossil-diesel from conventional oil. A number of references will be used to provide fossil-diesel data, with the primary reference being "Assessment of the Environmental Performance and Sustainability of Biodiesel in Canada" prepared by Rollefson, Fu and Chan of the National Research Council (NRC) in 2003.

7.2 Fossil-diesel Life Cycle Analysis for Canada

As detailed by Rollefson et al², Canada has unique problems associated with our growing dependence on synthetic oil derived from Alberta's heavy oil and tar sands bitumen. Rollefson states:

"Diesel oil production in Canada is significantly different from most other countries, mainly due to the ever-increasing portion of its diesel derived from heavy and tar sand synthetic oil. The energy requirement for this synthetic oil is substantial. The tar or bitumen must be separated from the sand/clay by a process that typically includes steam, hot water and caustic soda. It is diluted with naphtha and then centrifuged to produce the liquid bitumen. This bitumen is then upgraded in a coking process and through hydrogenation to yield the synthetic oil."²

Based on the high upstream energy requirements of Canadian diesel fuel, it is expected that displacing a portion of fossil-diesel with biodiesel may provide greater benefit in the Canadian context than for nations whose fossil-diesel is derived primarily from conventional oil sources.

In order to provide a comparison to the biodiesel life cycle analyses detailed previously in the document, life cycle estimates for Canadian fossil-diesel developed by Rollefson et al² are presented in the following table (further detail provided in Appendix B). For the model used by Rollefson, the sulphur content of the diesel was assumed to be 50ppm, which is somewhat higher the legislated ultra-low sulphur diesel limit of 15ppm that will come into effect in 2006. However, according to Rollefson et al, the incremental energy required to reach the lower diesel sulphur content is not significant relative to other factors in the analysis².

One important simplification implicit on the data presented in the following table is the straight mass allocation of the refining inputs and outputs associated with diesel production. Rather than differentiating possible variations in energy requirements, inputs and emissions for the production of the different products refined from crude oil (gasoline, diesel, asphalt, coke), the analysis assumes that the inputs and outputs associated with diesel production represent the same fraction of the total inputs and outputs as the mass fraction of the diesel produced from the crude oil input².

Table 7-1 Total upstream^a emissions of 50ppm Sulphur diesel in Canada (GHGenius)

	Onshore	Offshore	Heavy	Central ^b
g/kg diesel	0.005% S	0.005% S	0.005% S	0.005% S
CO ₂ (not including other pollutants)	677	760	1115	960
CH ₄	8.7	9.3	12.1	10.9
N ₂ O	0.04	0.04	0.06	0.05
CFCs+HFCs	4E-05	5E-05	5E-05	5E-05
CO	3.5	4.5	8.8	6.9
NO _x	4.3	5.4	10.6	8.1
VOC-Ozone weighted	0.97	1.03	1.28	1.17
SO _x	1.46	1.55	1.94	1.77
PM	0.26	0.29	0.43	0.37
GHG emissions g(CO _{2eq})/kg	872	970	1390	1200

Notes:

Density 0.843kg/L with a carbon fraction 0.858,
Energy Content (HHV) 45.8 MJ/kg²

- a. Upstream includes oil production, leaks and flares, oil transportation to refinery, refining, fuel storage and distribution and dispensing.
- b. The central Canada mix for 2005 from GHGenius model, version 2.3a, is comprised of 27% light crude onshore (or conventional), 10% light offshore and 63% heavy oil. Heavy includes synthetic oil from the tar sands and heavier grades from Western Canada. The heavy oils are not differentiated for their overall energy inputs. Actual heavy oil input to diesel in 2004 for Ontario and Quebec is only about 30% so the estimate for of 63% for 2005 is high. The mix used in this report should therefore be considered as a mix appropriate to an average over central and western Canada².

7.3 Fossil-diesel Emission Discussion

In order provide a comparison to the data provided in the previous table for the upstream emissions associated with fossil-diesel production, the following table from Rollefson et al² is provided to illustrate the emissions from the end use of fossil-diesel in a bus.

Table 7-2 Urban Autobus emissions not including upstream emissions (GHGenius)

Vehicle operation Results for Buses (g/kg diesel)Year 2005	(undifferentiated data for different oil sources for 50- ppm maximum sulphur content			
	onshore	offshore	heavy	Central Canada
CO ₂ - not including other pollutants	3758			
CH ₄	0.245			
N ₂ O	0.166			
CO	0.004			
NO _x	41.9			
VOC, Ozone-Weighted	51.9			
SO _x ^a	3.95			
CFCs+HFCs	0.39			
PM	1.67			
GHG emissions (g(CO ₂ eq)/kg	3810			

Notes:

- a. SO_x emissions for 15 ppm diesel would be $15/50 = 0.3$ of these 50 ppm values. SO_x emissions for 500 ppm maximum sulphur do not scale directly as there is enough sweet crude oil available that the average sulphur content is often well below 500 ppm. Genius estimates SO_x emissions for 500 ppm max diesel to be 1.48g/kg (diesel)².

As the data in the previous two tables make clear, the carbon dioxide emissions associated with the end use of diesel fuel are roughly four to five times the emissions associated with upstream production. Still, the choice of upstream crude oil feedstock for diesel production provides to be significant, with upstream CO₂ emissions as low as 18% of end use for light offshore crude, or as high as 29.7% for heavy oil². Additionally, upstream oil production is also responsible for emissions of methane, another greenhouse gas with a IR radiation trapping potential 8-21 times greater than CO₂. Methane is typically released through leaks from oil production equipment and flaring, or directly from synthetic oil production processes. Depending on the oil source, methane emissions account for 18 to 21% of total upstream greenhouse gas emissions².

Summing the global warming potential for greenhouse gases CO₂, methane, and N₂O released in upstream production and end use for Canadian diesel fuel (made from 63% heavy oil, 37% light conventional oil) produces a total of 5018g (CO₂eq)/kg diesel. Upstream emissions of 1204g (CO₂eq)/kg account for 24% of the total greenhouse gas emissions from Canadian fossil-diesel production and end use². Clearly, upstream emissions represent a significant portion of total Canadian fossil-diesel lifecycle

emissions, which will continue to grow as heavy oil sources become more predominant in Canada's fossil energy supply.

7.4 Summary and Conclusions

As a result of the energy intensity of Canadian fossil-diesel production, the value of displacing fossil-diesel with biodiesel is magnified relative to countries with similar energy markets such as the US. US data provided by Rollefson et al ² indicates that greenhouse gases attributable to upstream production of US fossil-diesel are 52-64% of the Canadian totals, reflecting the fact the synthetic crude oils derived from heavy oil sources represent a much smaller portion of total US crude supply. For Canadian fossil-diesel fuel, upstream emissions of greenhouse represent up to 30% of the total lifecycle emissions.

For further reference, comprehensive tables summarizing the life cycle analysis data for Canadian fossil-diesel production² is provided in Appendix B.

8 The state of Life Cycle Analysis

Despite the heroic efforts of many researchers such as Rolefson et al. and DeLucci there are no up-to-date and regionally specific frameworks for comparing biodiesel and fossil diesel today. There are two reasons why this objective has proven to be so elusive:

1. The absence of a consensus on what impacts to measure as well as whether and how to combine different impacts?
2. The issue of keeping abreast of changing practices in a rapidly evolving industry with regionally differentiated emissions, options and practices.

Here each of these is taken in turn and examples are presented to highlight the challenges inherent in developing systematic assessments of different biofuels.

The idea of life cycle assessment arose from the concern that we need to be more cognizant of “system-wide” impacts associated with our activities. In other words, the inputs to any activity have their own inputs and the fate of any product and its inputs may have its own cluster of lasting impacts. We need to understand products and processes from cradle to grave or preferably to another cradle (in other words full recycling) in order to manage the earth and its resources in a sustainable manner.

This is a laudable starting point, however, there are many different frameworks for defining sustainability. For someone focused on climate change, all one may need to consider in comparing two alternative fuel sources could be simplified into a comparison of their net contributions to global warming potentials. Whereas for another person concerned about the health of freshwater aquatic ecosystems their measure of sustainability may well revolve around a comparison of **the** Eutrophication Potential of the various options.

Niederl and Narodoslowsky⁸ summarise their evaluation of biodiesel made from beef tallow using six different assessment methods – see Table 8-1. Clearly, biodiesel would be judged as a brilliant alternative to fossil-diesel if there is agreement that Abiotic Depletion Potential is what we have to worry about, and it is a poor option if all we care about is a comparison of their Eutrophication Potentials.

More complex indices can be constructed by combining a number of assessment metrics. But in these we need to assign each criterion a unit and weight relative to others. This carries an implication of the relative importance of the various criteria. And yet, we know that many of these impacts are sensitive to their context and cannot be generalized into a universal set of priorities. In other words, in a region where photo-oxidants are a prominent concern the potential to create photo-oxidants would be the variable with the greatest weight, but even in such regions, the non-linear chemistry of photo-oxidant production is likely to render a linear calculus inappropriate. Therefore, Table 8-1 is not only an elegant display of how different assessment methods arrive at divergent evaluations, it also exemplifies how within each evaluation paradigm, there is an attempt to create a generalizable framework which in reality ought to be far more context specific.

Table 8-1 Comparison between different impact assessment methods (adapted from Niederl and Narodoslawsky⁸)

	Fuel combustion	Process energy	Process chemicals ^a	Transport ^b	Biodiesel as fraction of Fossil-Diesel
	[%]	[%]	[%]	[%]	[%]
SPI	42.5	18.0	22.0	17.8	17%
GWP	29.1	20.7	40.5	9.7	20%
AP	85.8	4.2	7.8	2.21	91%
EP	94.8	2.4	1.4	1.4	150%
ADP	0.7	67.1	2.0	30.2	7%
POCP	88.5	2.5	5.8	3.2	63%

Notes:

- a: Raw materials (apart from UVO) and auxiliaries used in transesterification process. While NO_x exhaust emissions from biodiesel are similar to those from diesel, the net lifecycle impact on NO_x emissions from biodiesel is very advantageous.
- b: Transport includes the collection of used vegetable oil and fuel delivery. **In the non-methane hydrocarbon emissions tow scenarios were introduced to account for**

SPI (Sustainable Process Index) in m²a

GWP (Global warming Potential) in kg CO₂ eq yr⁻¹ MJ⁻¹

AP (Acidification Potential) in kg SO₂ eq yr⁻¹ MJ⁻¹

EP (Eutrophication Potential) in kg PO₄ eq yr⁻¹ MJ⁻¹

ADP (Abiotic Depletion Potential) in kg antimony eq yr⁻¹ MJ⁻¹

POCP (Photooxidant Creation Potential) in kg ethylene eq yr⁻¹ MJ⁻¹

Secondly, there is the issue of regional and temporal variability in the production processes. For example, N₂O from soils is related to factors that are outside the immediate control of farmers (e.g., weather), somewhat under their control (e.g., soil microbial population) and integral to their response strategies in a volatile market for inputs to farming and outputs of farming (e.g., type, timing and amount of fertilizer used). As shown in chapter 2, the IPCC methodology for emission assessment overestimates emissions from Canadian canola farms in the Prairies by a factor of 10. Such discrepancies can render an option very favourable in one location and not so in another place or time.

Factors outside agriculture can also play a significant role in the options available to farmers. Today, concern about terrorism has largely removed ammonium nitrate from the market. Meanwhile, there is significant interest in timed-release fertilizer products. The rapid advances in these are attributed by some to the proliferation of golf courses. A little further into the future, will we be planting nitrogen-fixing canola? Will we have canola varieties expressly developed to maximize the oil yield? Will there be a market for significantly more canola meal if crushing capacity is expanded? Each of these factors has a characteristic time constant of evolution and market adoption. LCA methodologies need to update their input assumptions in step with these developments or the key process representations will be out of date and the evaluations erroneous.

There have been significant differences in previous lifecycle assessments (LCA) of biofuels. Two reasons behind these have been discussed. These will continue to challenge the current and future generations of LCA. Another particularly vexing challenge, that of how to attribute impacts to joint products, has thankfully now been solved. The boundary expansion approach to attribution of impacts recognises that price and mass attribution methods are too arbitrary. The system expansion approach notes that the joint products of biodiesel manufacturing from various feedstocks are all the same. Soy based biodiesel, and canola based biodiesel both produce protein, glycerine and biodiesel. They do so with different inputs of energy, land, water, and agrochemicals and also produce these joint products in different ratios. By using inputs associated with a number of streams of joint products, it is possible to set up a system of simultaneous equations allowing estimation of the inputs to and impacts from each product separately. The GHGenius modelling framework used as a benchmark study for this report here uses this advanced method.

In summary, we have reviewed the available literature on life-cycle assessment of biodiesel and given that body of evidence come to the conclusion that the promotion of biodiesel is sound public policy. We also note that these evaluations often lag farmer practices and are likely to be out of date. We draw attention to the need to more carefully review all high impact greenhouse gas emissions associated with biomass production. Farming practices are evolving continually. Over the past decade yields have climbed to unprecedented levels and just as surely as hybrid seeds have led to a fall in rates of application of agrochemicals there are likely to be new breakthroughs around the corner that change farmer practices and the net environmental impacts of biomass as a feedstock for liquid fuels.

9 References

1. Theresa A Brimner, Gordon James Gallivan, Gerald R Stephenson,. Influence of herbicide-resistant canola on the environmental impact of weed management. *Pest Manag Sci.* 2005;61:47-52.
2. Rollefson J, Fu G, Chan A. Assessment of the environmental performance and sustainability of biodiesel in canada. National Research Council; 2004. Available from:
http://www.studio255.com/crfa/pdf/res/2004_11_NRCBiodieselProjectReportNov04.pdf.
3. Canola Council of Canada website. Available at: <http://www.canola-council.org/>. Accessed 19 May, 2006.
4. (S&T)2. Biodiesel GHG emissions using GHGenius: An update. Canada:2005. Available from:
http://www.studio255.com/crfa/pdf/res/20050311_NRCan_Biodiesel_GHG_Emissions.pdf.
5. Sheehan J, Camobreco V, Duffield J, Graboski M, Shapouri H. Life cycle inventory of biodiesel and petroleum diesel for use in an urban bus. USA:1998;NREL/SR-580-24089 UC Category 1503. Available from:
<http://www.nrel.gov/docs/legosti/fy98/24089.pdf>.
6. The Canadian Soybean Export Association (CSEA) website. Available at: <http://www.canadiansoybeans.com/>. Accessed May 23, 2006.
7. Levelton, (S&T)2. Assessment of biodiesel and ethanol diesel blends, greenhouse gas emissions, exhaust emissions, and policy issues. 2002. Available from:
http://www.studio255.com/crfa/pdf/res/200209_Assessment_of_Biodiesel_and_E_Diesel.pdf.
8. NIEDERL A, NARODOSLAWSKY M. Ecological evaluation of processes based on by-products or waste from agriculture: Life cycle assessment of biodiesel from tallow and used vegetableoil. *A.C.S.symposium series.* 2006;921:239-252.
9. SMC, SERECON MANAGEMENT CONSULTING INC, KP, KOCH PAUL ASSOCIATES. An agronomic and economic assessment of transgenic canola. 2001. Available from: http://www.canola-council.org/report_gmo.html.
10. CARC, BIOCAP. An assessment of the opportunities and challenges of a bio-based economy for agriculture and food research in canada. canada:

Canadian Agri-Food Research Council (CARC); 2003. Available from:
<http://www.carc-crac.ca/common/Opportunities%20and%20Challenges%20of%20a%20Bio%20based%20Economy.pdf>.

11. Wang MQ. GREET 1.5 -- transportation fuel-cycle model. Center for Transportation Research, Energy Systems Division, Argonne National Laboratory;; 1999;ANL/ESD-39, Vol. 1. Available from:
http://www.transportation.anl.gov/software/GREET/pdfs/esd_39v1.pdf.

12. Ontario soybean growers website. . Accessed May 23, 2006.

13. Gold MV. Sustainable Agriculture: Definitions and Terms.

14. Canadian fertilizer consumption, shipments and trade — 1999/2000 Agriculture and Agri-Foods Canada; . Available from:
http://www.agr.gc.ca/spb/fiap-dpraa/publications/canfert/canfert9900/cf99_00_1_e.php. Accessed 06/21/2006.

15. Xianqiang Z, Rodney M. Agriculture and agri-foods canada: Farm fuel and fertilizer expenses. *Bi-weekly Bulletin*. 2006;19:1-4.

16. Follett RF. Soil management concepts and carbon sequestration in cropland soils. *Soil and Tillage Research*. 2001;8;61:77-92.

17. West TO, Post WM. Soil organic carbon sequestration rates by tillage and crop rotation: A global data analysis. *Soil Sci Soc Am J*. 2002;66:1930-1946.

18. Paustian K, Andren O, Janzen HH, et al. Agricultural soils as a sink to mitigate CO₂ emissions. *Soil Use Manage*. 1997;13:230-244.

19. Delucchi M. A lifecycle emissions model (LEM): Lifecycle emissions from transportation fuels, motor vehicles, transportation modes, electricity use, heating and cooking fuels, and Materials . USA: Institute of Transportation Studies, University of California, Davis; 2003;UCD-ITS-RR-03-17. Available from:
<http://repositories.cdlib.org/itsdavis/UCD-ITS-RR-03-17>.

20. Helgason B, Janzen H, Chantigny M, et al. Toward improved coefficients for predicting direct N₂O emissions from soil in canadian agroecosystems. *Nutr Cycling Agroecosyst*. 2005;72:87-99.

21. Rochette P, Janzen HE-. Towards a revised coefficient for estimating N₂O emissions from legumes. *Nutr Cycling Agroecosyst*. 2005;73:171-179.

22. Delucchi MA. LIFECYCLE ANALYSES OF BIOFUELS, draft manuscript, may 2006. USA: Institute of Transportation Studies, University of California, Davis; 2006. Available from: http://www.its.ucdavis.edu/publications/2006/LCAs_of_Biofuels.pdf.
23. Wagner-Riddle C, Thurtell GWE-. Nitrous oxide emissions from agricultural fields during winter and spring thaw as affected by management practices. *Nutr Cycling Agroecosyst*. 1998;52:151-163.
24. Tyson KS, Bozell J, Wallace R, Petersen E, Moens L. Biomass oil analysis: Research needs and recommendations. *Office*. ;303:275-3000.
25. Chuanliang Su. Alberta 2001 Crop Season in Review with Feed and Harvest Summary Report.
26. Chapagain AK, Hoekstra AY. Water footprints of nations volume 2: Appendices. value of water research report. *Value of Water Research Report Series No.* 2004;2.
27. Edwards JU. Healthy north dakota oils. agriculture to health. North Dakota State University.; 2005. Available from: <http://www.ag.ndsu.edu/food/factsheet/oil-ag2health.pdf>.
28. Philippines: Bureau of Agricultural Statistics. Coconut yield 2001. coconut crop yield data by year. .
29. Norman K, Wieck L, Harden P, Baker G. Peanut production guide. Peanut Company of Australia (PCA); 2005. Available from: <http://www.pca.com.au/articles.php?rc=517>.
30. Magness JR, Compton CC. Food and feed crops of the united states. . 1971.
31. Starner DE, Hamama AA, Bhardwaj HL. Canola oil yield and quality as affected by production practices in virginia. *Perspectives on new crops and new uses.ASHS Press, Alexandria, VA*. 1999:254–256.
32. Mündel HH, Blackshaw RE, Byers JR, et al. Safflower production on the canadian prairies revisited in 2004. Agriculture and Agri-food Canada; 2004;Catalogue No.: A42-101/2004E. Available from: http://res2.agr.ca/Lethbridge/safflo/pdf/saff_v2_e.pdf.
33. Pimentel DM, Patzek TWM. Ethanol production using corn, switchgrass, and wood; biodiesel production using soybean and sunflower. *Natural Resources Research*. 2005;14:65-76.

34. canolainfo website. Available at:
<http://www.canolainfo.org/html/processing.html>. Accessed May 19, 2006.
35. Ma F, Hanna MA. Biodiesel production: A review. *Bioresour Technol.* 1999;70:1-15.
36. Saka S, Kusdiana D. Biodiesel fuel from rapeseed oil as prepared in supercritical methanol. *Fuel.* 2001;80:225-231.
37. DEMIRBAS A. Biodiesel from vegetable oils via transesterification in supercritical methanol. *Energy conversion and management.* 2002;43:2349-2356.
38. Korus RA, Hoffman D, Bam N, Peterson C, Drown D. TRANSESTERIFICATION PROCESS TO MANUFACTURE ETHYL ESTER OF RAPE OIL. *The Proceedings of the First Biomass Conference of the Americas: Energy, Environment, Agriculture, and Industry.* 1993:815-826.
39. Peterson C, Hammond B, Reese D, Thompson J, Beck S. Performance and durability testing of diesel engines using ethyl and methyl ester fuels.unpub. MS thesis. Moscow, Idaho: Agric. Engineering Dept., University of Idaho; 1995. Available from:
http://www.biodiesel.org/resources/reportsdatabase/reports/gen/19951231_gen-158.pdf.
40. Peterson CL, Reece DL. Emissions tests with an on-road vehicle fueled with methyl and ethyl esters of rapeseed oil. *Emissions Tests with an On-Road Vehicle Fueled with Methyl and Ethyl Esters of Rapeseed Oil.* 1994.
41. International Tanker Owners Pollution Federation(ITOPF) website. Available at: <http://www.itopf.com/stats.html>. Accessed May 31, 2006.
42. US Coast Guard website. Available at: <http://www.uscg.mil/hq/g-m/nmc/response/stats/Summary.htm>. Accessed 31, 2006.
43. Environment Canada website- Environmental Emergencies. Available at: <http://www.ec.gc.ca/ee-ue/default.asp?lang=en&n=A8F7B4B8>. Accessed May 30, 2006.
44. Tyson KS, Bozell J, Wallace R, Petersen E, Moens L. Biomass oil analysis: Research needs and recommendations. *Office.* ;303:275-3000.
45. Stolz JF, Follis P, Buzzelli J, Floro G, Donofrio R, Griffin WM. Aerobic and anaerobic biodegradation of soy diesel in freshwater and soil environments. 1995. Available from:

http://www.biodiesel.org/resources/reportsdatabase/reports/gen/19950101_gen-273.pdf.

46. Lapinskiene A, Martinkus P, Rebzdaite V. Eco-toxicological studies of diesel and biodiesel fuels in aerated soil. *Environ Pollut.* 2006;142:432-437.
47. Zhang X, Peterson C, Reece D, Haws R, Moller G. Biodegradability of biodiesel in the aquatic environment. *Trans ASAE.* 1998;41:1423-1430.
48. FERNÁNDEZ-ÁLVAREZ P, Joaquim V, GARRIDO JM, GRIFOLL M, Juan M. Use of biodiesel as cleaning and bioremediation agent in oiled shores. .
49. Mudge S. Shoreline treatment of spilled vegetable oils. *SPILL SCIENCE AND TECHNOLOGY BULLETIN.* 2000;5:303-304.
50. Scharmer K. Biodiesel energy-and environmental evaluation rapeseed-oil-methyl-ester. *Biodiesel Energy-and Environmental Evaluation Rapeseed-Oil-Methyl-Ester.* 2001.
51. Environmental Protection Agency. Health assessment document for diesel engine exhaust. Washington, D.C.: National Center for Environmental Assessment; 2002;EPA/600/8-90/057F.
52. Sawyer RF, Harley RA, Cadle SH, Norbeck JM, Slott R, Bravo HA. Mobile sources critical review: 1998 NARSTO assessment. *Atmos Environ.* 2000;34:2161-2181.
53. Placet M, Mann CO, Gilbert RO, Niefer MJ. Emissions of ozone precursors from stationary sources: A critical review. *Atmos Environ.* 2000;34:2183-2204.
54. National Research Council. *Modeling Mobile Source Emissions.* National Academic Press; 2000.
55. Gertler AW, Wittorff DN, {McLaren} R, Belzer W, Dann T. Characterization of vehicle emissions in vancouver B.C. during the 1993 lower fraser valley oxidants study. *Atmos Environ.* 1997;31:2107-2112.
56. Environmental Protection Agency. A comprehensive analysis of biodiesel impacts on exhaust emissions. Air and Radiation; 2002.
57. Souligny M, Graham L, Rideout G, Hosatte P. Heavy-duty diesel engine performance and comparative emissions measurements for different biodiesel blends used in the montreal BIOBUS project. SAE Technical Paper Series; 2004.

58. McCormick RL, Tennant CJ, Hayes RR, et al. Regulated emissions from biodiesel tested in heavy-duty engines meeting 2004 emission standards. 2005.
59. Lipman T, Delucchi M. A lifecycle emissions model (LEM): Lifecycle emissions from transportation fuels, motor vehicles, transportation modes, electricity use, heating and cooking fuels and materials. Institute of Transportation Studies, University of California (Davis); 2003.
60. Emissions Research and Measurement Division. Emissions characterization of a caterpillar 3126E equipped with a prototype SCRT system with ultra low sulphur diesel and a biodiesel blend. Environment Canada, Environmental Technology Centre; 2005.
61. Wang WG, Lyons DW, Clark NN, Gautam M, Norton PM. Emissions from nine heavy trucks fueled by diesel and biodiesel blend without modification. *Environmental Science & Technology*. 2000;34:933-939.
62. Emissions Research and Measurement Division. Evaluation of emissions from the on road testing of two urban transit buses operating on a biofuel blend (B20) in the halifax regional municipality. Environment Canada, Environmental Technology Centre; 2005;04-19.
63. Durbin TD, Norbeck JM. Effects of biodiesel blends and ARCO EC-diesel on emissions from light heavy-duty diesel vehicles. *Environmental Science and Technology*. 2002;36:1686-1691.
64. Fritz SG. Evaluation of biodiesel fuel in an EMD GP38-2 locomotive. National Renewable Energy Laboratory; 2004.
65. Sine Nomine Group. Biodiesel demonstration and assessment for tour boats in the old port of montreal and lachine canal national historic site. Sine Nomine Group; 2005,.
66. Krishna CR. Biodiesel blends in space heating equipment. Brookhaven National Laboratory; 2001.
67. Batey JE. Combustion testing of a bio-diesel fuel oil blend in residential oil burning equipment. Massachusetts oilheat council \& National oilheat Research Alliance; 2003.
68. Jacobson MZ. *Fundamentals of Atmospheric Modeling*. Cambridge University Press; 1999.
69. Seinfeld JH, Pandis SN. *Atmospheric Chemistry and Physics*. John Wiley and sons; 1998.

70. Sillman S. Tropospheric ozone: The debate over control strategies. *area*. 1993;18:31-56.
71. Schere KL, Hidy GM. Foreword: NARTSO critical reviews. *Atmos Environ*. 2000;34:1853-1860.
72. Mansell G, Morris RE, Wilson G. Impact of biodiesel fuels on air quality and human health: The impact of biodiesel fuels on ambient carbon monoxide levels in the las vegas nonattainment area. National Renewable Energy Laboratory; 2003.
73. Morris RE, Mansell GE, Jia Y, Wilson G. Impact of biodiesel fuels on air quality and human health: The impact of biodiesel fuels on ozone concentrations. National Renewable Energy Laboratory; 2003.
74. Morris RE, Jia Y. Impact of biodiesel fuels on air quality and human health: The impact of biodiesel fuels on PM. National Renewable Energy Laboratory; 2003.
75. Russell A, Dennis R. NARSTO critical review of photochemical models and modeling. *Atmos Environ*. 2000;34:2283-2324.
76. Heuss JM, Kahlbaum DF, Wolff GT. Weekday/weekend ozone differences: What can we learn from them? *Journal of the Air and Waste Management Association*. 2003;53:772-788.
77. Hedley M, Jiang W, McLaren R, Singleton DL. Modeling of future-year emissions control scenarios for the lower fraser valley: Impacts of natural gas and propane vehicle technologies. *J Appl Meteorol*. 1998;37:1190-1204.
78. Morris RE, Pollack AK, Mansell GE, Lindhjem C, Jia Y, Wilson G. Impact of biodiesel fuels on air quality and human health: Summary report. National Renewable Energy Laboratory; 2003.

10 Appendices

Appendix A - LCA Data for Canola and Soybean Agriculture

Rollefson et al² presents a detailed Life Cycle Analysis for canola and soybean agriculture which summarizes the inputs and outputs as detailed in the On Farm Operations & Environmental Impacts section. These tables are presented below, along with a list of the assumptions and conditions inherent in the preparation the analyses.

"The following conditions apply to the baseline analyses:

- *The average Canadian yields for canola and soybean are used.*
- *Field energy requirements are based on the new understanding of "conventional" till practices (with lower energy input due to the abandonment of the mouldboard plough).*
- *Fertilizer input requirements for P and K are determined on the basis of sustainability by determining levels needed to offset their rate of removal by the crop harvest.*
- *No nitrogen fertilizer is used for soybean and the crop is considered to have a net impact of zero on overall soil nitrogen content.*
- *Saskatchewan guidelines of 67kg/ha are used as the nitrogen fertilizer requirements for canola.*
- *The Canadian "slow-improvement" scenario is used to determine the energy inputs for fertilizer and, in particular, for urea.*
- *The "adjusted" estimation method of Agriculture and Agri-Food Canada is used to determine nitrous oxide emissions from the system.*
- *All figures are expressed in terms of inputs/emissions required to yield one kilogram of either canola or soybean."*

Table 10-1 Life Cycle Analysis Inputs for Canadian Canola and Soybean Production (kg inputs / tonne production)²

Inputs (kg)	Canola	Soybean
Crude oil (resource)	36.6	30.0
Hard coal (resource)	2.5	1.9
Lignite coal (resource)		0.3
Natural gas (resource)	79.3	3.9
Inert rock	3.1	4.3
Phosphorus minerals	70.0	50.0

Table 10-2 Life Cycle Inventory Outputs for Canadian Canola and Soybean Production (g outputs / tonne production)²

Outputs (g)	Canola	Soybean
Consumer waste	76.6	123.1
Hazardous waste	102.1	671.7
Radioactive waste		1.4
Ash		3.9

Outputs (g)	Canola	Soybean
Sludge	1179.9	
Ore processing residues	3098.4	1808.9
Overburden	268.4	2567.5
Ammonia	303.7	
Carbon dioxide	56725.8	33748.9
Carbon monoxide	262.5	132.4
Hydrogen chloride	1.4	1.0
Hydrogen sulphide	30.0	
Nitrogen oxides	660.5	197.6
Nitrous oxide	1196.3	1.8
Steam		1391.5
Sulphur dioxide	314.7	88.1
Ethane	82.5	
NMVOG (unspecified)	27.7	
Propane	33.1	
Methane	795.4	
VOC (unspecified)	93.6	
Halogenated organic emissions to air		117.3
Exhaust		1698.8
Particles to air	52.0	35.3
Biological oxygen demand (BOD)	1.0	
Chemical oxygen demand (COD)	8.8	9.3
Total organic bounded carbon	1.7	5.1
Ammonium / ammonia	160.8	
Chloride	38.5	335.3
Fluoride	1.5	
Neutral salts	166.8	268.4
Nitrate	554.0	
Phosphate		180.1
Potassium		140.2
Sodium	32.8	40.3
Sulphate		2.3
Hydrocarbons to water		1.3
Solids (suspended)		45.9
Boiler ash (unspecified)		3.4
Fly ash (unspecified)		10.4
Gypsum		1.5
Gypsum (FDI)		5.9
waste (inert)	941.0	672.0

Appendix B- LCA Data for Fossil-diesel

The following tables from Rollefson et al² provide fossil-diesel emission breakdown by production stage (g/kg diesel) for 50ppm sulphur.

Table 10-3 Leaks and flares

CH4 and CO2 leaks and flares	All Sources of Diesel
CO2 - not including other pollutants	37.245
CH4	6.0196
N ₂ O	0
CO	0
NO _x	0
VOC, Ozone-Weighted based on Sheet F factors	0.3171
SO _x	0.2629
CFCs+HFCs	0
PM	0

Table 10-4 LCA of fossil oil production

Oil Production (g/kg diesel (0.005% S diesel))				
Oil production	Onshore	Offshore	Heavy	Central Canada
CO ₂ - not including other pollutants	208.57	285.57	612.58	468.54
CH ₄	1.6306	2.2346	4.7996	3.6698
N ₂ O	0.0083	0.0113	0.0244	0.0186
CO	2.4973	3.4215	7.3466	5.6176
NO _x	2.8577	3.915	8.4054	6.4274
VOC, Ozone-Weighted	0.1496	0.2049	0.4397	0.3363
SO _x	0.2282	0.3125	0.6707	0.5129
CFCs+HFCs	9E-07	1E-06	2E-06	2E-06
PM	0.0779	0.1066	0.2283	0.1747

Table 10-5 LCA of oil transport to refinery

Oil Transport to Refinery (0.005% S diesel)				
Oil transport to refinery	Onshore	Offshore	Heavy	Central Canada
CO ₂ - not including other pollutants	7.8214	7.8441	7.9406	7.8981
CH ₄	0.0493	0.0494	0.0502	0.0499
N ₂ O	0.0004	0.0004	0.0004	0.0004
CO	0.0127	0.013	0.0141	0.0136
NO _x	0.0249	0.0252	0.0265	0.0259
VOC, Ozone-Weighted	0.1014	0.1014	0.1014	0.1014
SO _x	0.0237	0.0237	0.0238	0.0237
CFCs+HFCs	1E-06	1E-06	1E-06	1E-06
PM	0.0055	0.0055	0.0055	0.0055

Table 10-6 LCA of oil refining

Refining (g/kg diesel) (0.005% S diesel)				
Refinery	Onshore	Offshore	Heavy	Central Canada
CO ₂ - not including other pollutants	363.44	369.21	393.73	382.93
CH ₄	0.8435	0.8888	1.0812	0.9964
N ₂ O	0.0297	0.03	0.0309	0.0305
CO	0.5975	0.6668	0.9611	0.8315
NO _x	0.8083	0.8875	1.2242	1.0759
VOC, Ozone-Weighted	0.3483	0.3524	0.37	0.3623
SO _x	0.8657	0.872	0.8989	0.8871
CFCs+HFCs	6E-07	6E-07	7E-07	7E-07
PM	0.1043	0.1064	0.1156	0.1115

Table 10-7 LCA of fuel storage and distribution

Fuel Storage and Distribution (g/kg diesel) (0.005% S diesel)				
Fuel storage, distribution	Onshore	Offshore	Heavy	Central Canada
CO ₂ - not including other pollutants	54.773	55.525	58.72	57.313
CH ₄	0.1137	0.1196	0.1447	0.1336
N ₂ O	0.0023	0.0024	0.0025	0.0024
CO	0.3935	0.4025	0.4409	0.424
NO _x	0.5346	0.5449	0.5888	0.5695
VOC, Ozone-Weighted	0.0498	0.0503	0.0526	0.0516
SO _x	0.0598	0.0607	0.0642	0.0626
CFCs+HFCs	4E-05	4E-05	4E-05	4E-05
PM	0.0728	0.0731	0.0742	0.0737

Table 10-8 LCA of fuel dispensing

Fuel Dispensing (g/kg diesel) (0.005% S diesel)				
Fuel dispensing	Onshore	Offshore	Heavy	Central Canada
CO ₂ - not including other pollutants	5.061	5.0629	5.0713	5.0676
CH ₄	0.0097	0.0098	0.0098	0.0098
N ₂ O	0.0003	0.0003	0.0003	0.0003
CO	0.0017	0.0018	0.0019	0.0018
NO _x	0.0083	0.0083	0.0084	0.0083
VOC, Ozone-Weighted	0.0023	0.0023	0.0023	0.0023
SO _x	0.0197	0.0197	0.0198	0.0197
CFCs+HFCs	7E-09	7E-09	7E-09	7E-09
PM	0.0013	0.0013	0.0013	0

